

56 Sparta Avenue • Newton, New Jersey 07860
 (973) 300-3000 Sales • (973) 300-3600 Fax
 www.thorlabs.com



CM1002 - April 18, 2017

Item # CM1002 was discontinued on April 18, 2017. For informational purposes, this is a copy of the website content at that time and is valid only for the stated product.

CERNA™ MICROSCOPE WITH SIX-CUBE EPI-ILLUMINATOR

- ▶ Equipped with Six-Cube Epi-Illuminator
- ▶ Ready to Accept Objectives, Cameras, Filters, and Illumination Sources

Modular and Configurable

CM1002
 Cerna™ Microscope
 (Optical Table Not Included)



[Hide Overview](#)

OVERVIEW

Features

- Six-Cube Epi-Illuminator Accepts Visible Broad-Spectrum Lamps or Lamps with Ø3 mm Liquid Light Guides
- Large and Open Working Space Underneath the Objective Ideal for Sample Apparatuses, Recording Chambers, and Micromanipulators
- Accepts C-Mount Cameras from Thorlabs and Most Major Manufacturers
- Motorized Focus Control of Objective
- Trinoculars with 10X Eyepieces

The CM1002 Cerna™ Microscope provides a preconfigured optical path that is ideal for experiments requiring epi-illumination or reflected-light imaging. The epi-illuminator accepts up to six filter cubes, ideal for targeting spectrally separated fluorophores, while the microscope body has ample space beneath the objective for adding Thorlabs' sample stages, micromanipulators, and other accessories needed for fluorescence imaging of *in vivo* or *in vitro* samples. A motorized objective holder provides 1" of vertical focusing adjustment for the objective.

Trinoculars with a 1X camera port support real-time viewing of the sample directly through the eyepieces. The C-mount-threaded camera port is compatible with most industry-standard cameras, which can be used to view the sample on a computer screen in real time or to capture images to analyze later.

Unlike competing microscopes with similar capabilities, the Cerna™ platform's modularity lets the user quickly install and remove the microscope modules as needed for each experiment, providing a high degree of access and control. The open space beneath the objective provides ample room for *in vivo* imaging. Alternatively, *in vitro* samples can be studied by positioning sample stages below the objective using fixed arms that can be attached directly to the microscope or rigid stands. A variety of mounting surfaces are offered, allowing custom components to be integrated with your experiment.

To address a wide range of experimental parameters, Thorlabs offers eight preconfigured Cerna microscopes, which are summarized in the table below. In addition, we can work with you to configure a microscope that meets your unique needs. To contact our team, please e-mail ImagingSales@thorlabs.com. We also offer Cerna™ components individually for customers interested in building their own microscope.



Click to Enlarge
 A side view of the CM1002 Cerna™ Microscope
 (Optical Table Not Included)

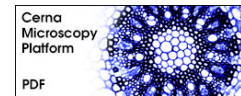

Cerna™ Microscopes	CM1001	CM1002	CM1003	CM2001	CM2002	CM3001	CM3002	CM3003(M)
Objective Holder	Single	Single	Single	Dual	Dual	Dual	Dual	Dual

Epi-Illumination	1 Cube	Up to 6 Cubes	1 Cube	Up to 6 Cubes	Up to 6 Cubes	Up to 6 Cubes	Up to 6 Cubes	Up to 6 Cubes
Trans-Illumination	-	-	Brightfield (Visible)	Brightfield (Visible)	Dot Contrast and Brightfield (Visible)	Dot Contrast and Brightfield (Visible and NIR)	DIC Imaging and Brightfield (Visible and NIR)	DIC Imaging and Brightfield (Visible and NIR)
XY Motion	-	-	-	-	-	Microscope Translator	-	Translating Platform

[Hide Microscope Design](#)

MICROSCOPE DESIGN

CM1002 Cerna™ Microscope

Entirely constructed from our line of modular components, this Cerna™ microscope includes several convenient features for imaging, which are highlighted below. We also offer a selection of microscope objectives, cameras, and illumination modules that can be used to complement your CM1002 Cerna microscope and customize it to your experiment. Details can be found on the *Accessories* tab. The *Shipping List* tab details the components used in this microscope, as well as a link to each component's webpage, where additional information (such as mechanical drawings) is available.

Epi-Illumination

Features

- Six-Cube Epi-Illuminator Module (Filter Cubes and Sets Sold Separately)
- Compatible Light Sources
 - XCITE120LED Broad Spectrum LED Lamp
 - HPLS343 Lamp with Liquid Light Guide (Requires LLG3A5-A Adapter)
 - XCITE200DC Lamp with Liquid Light Guide
 - Other Illumination Sources with a Nikon Bayonet Mount

This microscope is able to target multiple fluorophores through the use of a six-cube epi-illuminator that couples light emitted by the illumination source into the imaging path, through the objective, and onto the sample; it also allows epi-fluorescence generated by the sample to pass through the module to the eyepieces and camera. A standard Nikon bayonet mount on the rear of the microscope accepts a wide range of white-light lamps. The intensity of illumination at the sample can be adjusted using the three neutral density (ND) filters mounted in black sliders at the back of the housing, as seen in the image to the lower left.

Add-Ons: Epi-Illumination

- Illumination Sources
 - X-Cite LED and Broad Spectrum Lamps
 - High-Power Light Source with Liquid Light Guide
- Epi-Fluorescence Filter Cubes
- Epi-Fluorescence Filter Sets



[Click to Enlarge](#)

The CM1002 Cerna™ microscope features an epi-illuminator with a 6-cube filter turret. The filter position is labeled on the ring that rotates the turret. Three black sliders at the back of the housing contain neutral density filters.



[Click to Enlarge](#)

The rotating turret accommodates up to six filter cubes (not included).



[Click to Enlarge](#)

The back of the epi-illuminator has a bayonet mount for installing liquid light guides and LEDs.

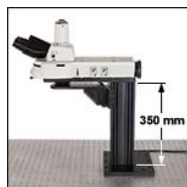

[Click to Enlarge](#)

The microscope body is based on a 95 mm optical rail.

Microscope Body

Features

- Large Working Volume: Optical Path is 7.74" (196.6 mm) Away from Edge of Rail
- Linear Dovetail Surface Allows Modules to be Added and Removed
- 350 mm Body Height to Accommodate Sample Stages Mounted on Rigid Stands or Fixed Arms
- Motorized Objective Focusing Module with 1" Travel
- Mechanically Compatible with Thorlabs' 95 mm Rail Platforms

The backbone of the CM1002 Cerna™ Microscope is the 350 mm tall microscope body based on Thorlabs' 95 mm Optical Rails, providing stable long-term support and excellent vibrational damping. Its linear dovetail mounting surface allows modules to be removed when they are not needed, freeing additional workspace and opening the door to user customization. For alternate rail heights, please see the full web presentation.



[Click to Enlarge](#)

This Cerna™ microscope includes trinoculars with a 1X camera port for widefield viewing.

Widefield Viewing

Features

- Fixed 1X Magnification Camera Port with C-Mount Accepts Most Industry-Standard Cameras
- Trinoculars with 10X Eyepiece Magnification and Adjustable Interpupil Distance

Add-On: Widefield Viewing

- Scientific Cameras

Widefield viewing on the CM1002 Cerna™ Microscope is provided by trinoculars and a 1X Camera Tube. The eyepieces feature an adjustable interpupil distance and rotate individually to allow the focus to be coarsely adjusted for each eye. The total system magnification for an image viewed through the eyepieces will be the objective magnification multiplied by 10.

The included camera tube contains all of the optics needed to image the light from the objective onto a camera sensor. The tube has 1X magnification, which means that the image will match the design field of view of the chosen widefield objective. External C-mount (1.000-32") threads on the top of the camera tube accept Thorlabs' scientific cameras, as well as cameras from most major manufacturers. For additional viewing port and camera tube options, please see the full web presentation.



Click to Enlarge
The CM1002 Cerna™ Microscope has a single objective holder (objective not included).

Objective Holder

Features

- Threaded for M32 x 0.75 Objectives
- Included Adapters:
 - M25 x 0.75-Threaded Objectives (Nikon)
 - RMS-Threaded Objectives (Olympus)

Add-On: Objectives

- Microscope Objectives

The Single-Objective Nosepiece connects to the motorized mounting arm on the microscope body via six M4 counterbores to provide 1" of motorized vertical translation of the objective. The nosepiece features an M32 x 0.75 threaded port for mounting objectives and includes two adapters to provide compatibility with other common objective threads: M25 x 0.75 (Nikon) and RMS (Olympus). Microscope objectives are available for purchase separately from Thorlabs, and we can also order other objectives from either Nikon or Olympus upon request. To mount multiple objectives, please see the full web presentation for other mounting options.

objectives from either Nikon or Olympus upon request. To mount multiple objectives, please see the full web presentation for other mounting options.

[Hide Accessories](#)

ACCESSORIES

Selected Accessories

In order to image with this microscope, it is necessary to add scientific cameras, an epi-illumination source, filter cubes and filter sets, objectives, and sample holders. It is often possible to improve the quality of your experimental data by carefully selecting accessories that complement your specific experiment. To that end, we have ensured that Cerna™ microscopes are compatible with a wide range of accessories. The information below compares the Cerna-compatible components that are manufactured or sold by Thorlabs. We have also indicated when it is possible to use equipment designed by other manufacturers.

Content

- Scientific Cameras for Widefield Viewing
- Illumination Sources for Epi-Illumination
- Filter Cubes and Filter Sets for Epi-Fluorescence
- Illumination Kits
- Objectives
- Sample Holders

Application-Optimized Cerna™ Microscopes

[Contact Us](#)

Developed in collaboration with our colleagues in the field, the Cerna microscopy platform is uniquely modular and flexible, making it adaptable to a wide range of demanding experimental requirements. If you would like to work with our application specialists, engineers, and sales team to design your own microscope, please email ImagingSales@thorlabs.com.

Scientific Cameras for Widefield Viewing

- Visualize the Field of View at a Computer
- Any C-Mount Camera is Compatible with a Cerna™ Microscope

Thorlabs offers scientific cameras optimized for a range of imaging needs. Cameras allow the field of view to be displayed on a computer screen and saved for later reference. Viewing your sample from a computer also enables remote sample positioning using our motion control accessories (see below), allowing samples to be moved in sensitive setups without introducing additional vibrations from your hands.

The CM1002 Cerna™ microscope includes a 1X camera tube, which provides a fixed magnification at the image plane equal to the objective magnification.

Any camera with C-Mount (1.000"-32) threading is compatible with this microscope. The most popular cameras used with Cerna systems are given in the table below. Higher resolution options can be found in our complete range of scientific cameras.



Click to Enlarge
The camera port provides fixed 1X magnification for visible light from the sample.

Item #	DCU224M	340M-USB	1501M-USB
Product Photo (Click to Enlarge)			
Primary Feature	Lightweight	Fast Frame Rate	High Resolution and Dynamic Range
Sensor Type	Sony ICX205AL	On Semi / Truesense KAI-0340 Monochrome CCD	Sony ICX285AL Monochrome CCD (Grade 0)

Sensor Format	1/2" (7.62 mm Diagonal)	1/3" Format (5.92 mm Diagonal)	2/3" Format (11 mm Diagonal)
Resolution	1280 x 1024 Pixels	640 x 480 Pixels	1392 x 1040 Pixels
Pixel Size	4.65 μm x 4.65 μm	7.4 μm x 7.4 μm	6.45 μm x 6.45 μm
Frame Rate (Max)	15 fps	200.7 fps	23 fps
Host PC Interface	USB 2.0 (Cable Included)	USB 3.0 (Cable Included)	
Digital Output	8 Bits	14 Bits	14 Bits
Mass	96 g (0.21 lbs)	750 g (1.65 lbs)	

Illumination Sources for Epi-Illumination

- White Light Sources Illuminate the Field of View Through the Objective
- Available Options Include Liquid Light Guide and Broad-Spectrum LED Lamps
- Light is Conditioned by Filter Cubes and Filter Sets for Specific Fluorophores (See Below)

The six-cube epi-illuminator module that is included with this Cerna™ microscope requires a broadband white light source that emits across the visible region of the spectrum. Broadband emission makes it possible for the same microscope to stimulate fluorophores that have absorption wavelengths that are spectrally separated. Several filter sets aimed at common fluorophores are available below.



Click to Enlarge
A Bayonet-to-LLG Adapter is Being Attached to the Six-Cube Epi-Illuminator Module

All three lamps offered by Thorlabs provide emission throughout the visible range, local intensity control from the front panel of the light source, and external intensity control via BNC and/or USB 2.0. They are equipped with a flexible liquid light guide (LLG) that makes it easy to position the lamp around the rest of your equipment.

Any illumination source that can be coupled to a Nikon bayonet mount is compatible with Cerna™ microscopes. For example, Thorlabs' LLG3A5-A adapter connects any Ø3 mm LLG to a Nikon bayonet mount. We also manufacture lamphouse port adapters that make Nikon bayonet mounts compatible with our Ø1" or Ø2" lens tubes.



Click to Enlarge

HPLS343 Features

- ▶ Output Spectrum: 350 - 800 nm
- ▶ Intensity is Variable from 0.1% to 100% Using Knob
- ▶ External Control via USB 2.0 or BNC Inputs
- ▶ Lifetime: 10,000 Hours (Average)
- ▶ Includes Ø3 mm, 1.2 m (4') Long LLG
- ▶ Requires LLG3A5-A Collimating Adapter (Sold Separately)
- ▶ Link to Full Web Presentation



Click to Enlarge

XCITE200DC Features

- ▶ Output Spectrum: 340 - 800 nm
- ▶ Intensity is Variable from 0% to 100% Using Knob
- ▶ External Control via BNC Input
- ▶ Lifetime: >2,000 Hours Minimum; >2,500 Hours Typical
- ▶ Includes Ø3 mm, 5' (1.5 m) Long LLG and Nikon Bayonet Mount
- ▶ Link to Full Web Presentation

Filter Cubes and Filter Sets for Epi-Fluorescence

- Tune Epi-Illumination Source for the Excitation and Detection of Specific Fluorophores
- Up to Six Filter Cubes can be Installed Simultaneously
- Cerna Microscopes are Compatible with Fluorescence Filters from All Major Manufacturers
- Select Filter Sets Available Pre-Installed in Microscope Filter Cubes
- Other Filter Sets Available



Click to Enlarge
TLV-TE2000 Filter Cube Accepts: Excitation Filter (Ø25 mm, up to 5 mm Thick), Emission Filter (Ø25 mm, up to 3.5 mm Thick), and Dichroic Mirror (up to 25.2 mm x 36.0 mm x 1.1 mm)

Filter Transmission Spectra ^a		
Item #	Target Fluorophore	Transmission Graph (Click for Plot)
MDF-BFP	BFP (Blue Fluorescent Protein)	
MDF-GFP2	Alexa Fluor® 488	
MDF-MCHA ^b	mCherry	
MDF-MCHC ^c	mCherry	
MDF-TOM	tdTomato	

a. Please see the full web presentation for a complete listing of fluorescence filter sets offered.

b. This filter set's excitation range is centered around 578 nm, making it well matched to typical LEDs.

The epi-illumination module included with this microscope can hold up to six filter cubes at once, allowing the setup to target multiple fluorophores. A hand-operated turret is used to switch between the filter cubes, each of which holds a filter set that conditions the light emitted by the illumination source for a specific fluorophore, such as BFP, GFP, mCherry, or tdTomato.

c. This filter set's excitation range is centered around 562 nm, making it well matched to typical lamps.

The filter sets we offer, which consist of an excitation filter, an emission filter, and a dichroic mirror, come in the industry-standard sizes. For excitation and emission filters, the standard dimensions are Ø25 mm, while for dichroic mirrors, the standard dimensions are 25 mm x 36 mm. This allows Cerna™ microscopes to be compatible with filters from all major manufacturers.

Several popular filter sets are listed with their target fluorophores in the table to the right. If the filter cubes and filter sets are purchased at the same time, we will mount the filter sets in the filter cubes at no additional charge. Please contact Technical Support prior to purchase to take advantage of this service.

Objectives

- Cerna™ CM1002 Microscope Directly Accepts Objectives with M32 x 0.75 Threads
- Includes Thread Adapters for Compatibility with Objectives from Major Manufacturers
 - M25 x 0.75-Threaded Objectives (Nikon)
 - RMS-Threaded Objectives (Olympus)

The nospiece of this microscope has one M32 x 0.75-threaded bore for mounting objectives. The M32 x 0.75 thread standard is used by newer widefield microscope objectives and offers larger back apertures than previous standards. M25 x 0.75- and RMS-threaded adapters are included for compatibility with most objectives from Olympus and Nikon. Shown below are selected widefield Nikon objectives that are commonly used with the CM1002 Cerna Microscope. They can be mounted in the microscope's CSA1100 single-objective holder using the included M32 x 0.75 to M25 x 0.75 adapter. We also offer other objectives and can order other objectives from either Nikon or Olympus upon request.

Item #	N4X-PF	N10X-PF	N20X-PF	N40X-PF	N60X-PF
Photo (Click to Enlarge)					
Magnification	4X	10X	20X	40X	60X
Numerical Aperture (NA)	0.13	0.3	0.50	0.75	0.85
Working Distance (WD)	17.2 mm	16 mm	2.1 mm	0.66 mm	0.31 - 0.4 mm
Threading	M25 x 0.75				

Sample Stages and Holders

- Rigid Stands to Hold Samples Underneath and Around the Objectives
 - Designed for Slides, Petri Dishes, Well Plates, Recording Chambers, Micromanipulators, and Custom Inserts
 - Translation Stages with 1" of X and Y Travel Available
- Fixed Arms Allow Fast XY Stage, Lens Tubes, and/or Cage Systems to be Placed Directly Into the Optical Path
 - CSA1000: For Our MLS203-1 Fast XY Scanning Stage
 - CSA1001: For Ø1" Lens Tubes and 30 mm Cage Systems
 - CSA1002: For Ø2" Lens Tubes and 60 mm Cage Systems



Click to Enlarge
MP100-MLSH Rigid Stand with
MLS203P2 Slide/Petri Dish
Holder



Click to Enlarge
MLS203-1 Stage with
MLS203P2 Slide Holder on
CSA1000 Fixed Arm
(All Sold Separately)



Click for Details
MP100-RCH2 Slide Holder in a
Cerna Microscope

Thorlabs offers highly configurable solutions for mounting your sample beneath the objective of the Cerna™ Microscope. Rigid stands are available with multiple platform styles that can accept slides, petri dishes, recording chambers, micromanipulators, and custom inserts. The included collar makes them lockable at a height and angle chosen by the user. We also manufacture translation stages for these rigid stands that provide motorized horizontal translation of the sample.

Our fixed arms enable the sample stage to be attached directly to the microscope body via a dovetail that extends the full height of the microscope body, allowing the arms to be positioned anywhere along the body height. For a pre-configured sample holder solution, use the CSA1000 fixed arm with the MLS203-1 Fast XY Scanning Stage. This stage is compatible with our MZS500-E Piezo-Driven Insert, which adds high-resolution Z-axis adjustments. Alternatively, the CSA1001 and CSA1002 rigid arms are compatible with Thorlabs' wide selection of optomechanical components, allowing custom sample holder configurations and additional optics to be easily integrated the CM1002 Cerna microscope.

Several common options are outlined below, while our full selection of sample holders can be explored in the Cerna Components presentation.

Rigid Stands



[Click to Enlarge](#)

MP100-RCH2 Slide Holder

- ▶ Designed for Standard 3" x 1" (76.2 mm x 25.4 mm) Microscope Slides
- ▶ Height Range: 148.1 - 208.5 mm
- ▶ Other Heights Available



[Click to Enlarge](#)

MP100-MLSH Insert Holder

- ▶ Designed for Multiple Slides, Petri Dishes, Calibration Targets, Breadboards, Our MZS500-E Z-Axis Piezo Stage, and User-Designed Inserts
- ▶ Height Range: 148.1 - 208.5 mm
- ▶ Other Heights Available



[Click to Enlarge](#)

MP100-RCH1 Recording Chamber Holder

- ▶ Circular Hole Designed for Recording Chambers
- ▶ Height Range: 148.1 - 208.5 mm
- ▶ Other Heights Available



[Click to Enlarge](#)

MP100 Rigid Stand with Platform

- ▶ 24 M6 x 1.0 Tapped Holes for Holding Micromanipulators or Other Equipment
- ▶ Height Range: 148.1 - 208.5 mm
- ▶ Other Heights Available

Fixed Arms



[Click to Enlarge](#)

CSA1000 Fixed Arm

- ▶ Accepts MLS203-1 Fast XY Scanning Stage



[Click to Enlarge](#)

CSA1001 Fixed Arm

- ▶ Compatible with Ø1" Lens Tubes and 30 mm Cage Systems



[Click to Enlarge](#)

CSA1002 Fixed Arm





- ▶ Compatible with Ø2" Lens Tubes and 60 mm Cage Systems

[Hide Shipping List](#)

SHIPPING LIST

The microscope on this webpage is entirely constructed from our selection of modular Cerna™ components. This tab lists all of the components that the microscope contains.

Item #	Description	Photo (Click to Enlarge)
Microscope Body		
CEA1350	Cerna™ Microscope Body with Epi-Illumination Arm, 350 mm Rail Height	
Widefield Viewing		
WFA4000	Trinoculars with Eyepieces	
WFA4105	1X Camera Tube with C-Mount	
Epi-Illumination		

CSE1000	Epi-Illuminator Module for Six Filter Cubes (Filter Cubes Not Included)	
Objective Holder		
CSA1100	Single-Objective Nosepiece	
ZFM2020	Motorized Condenser Focusing Module with 1" Travel	
MCM3001	3-Axis Controller for Focus Control	

[Hide Microscope Guide](#)

MICROSCOPE GUIDE

Elements of a Microscope

This overview was developed to provide a general understanding of a Cerna microscope. Click on the different portions of the microscope graphic to the right or use the links below to learn how a Cerna microscope visualizes a sample.

- Terminology
- Microscope Body
- Illumination
- Sample Viewing/Recording
- Sample/Experiment Mounting

Click on the different parts of the microscope to explore their functions.

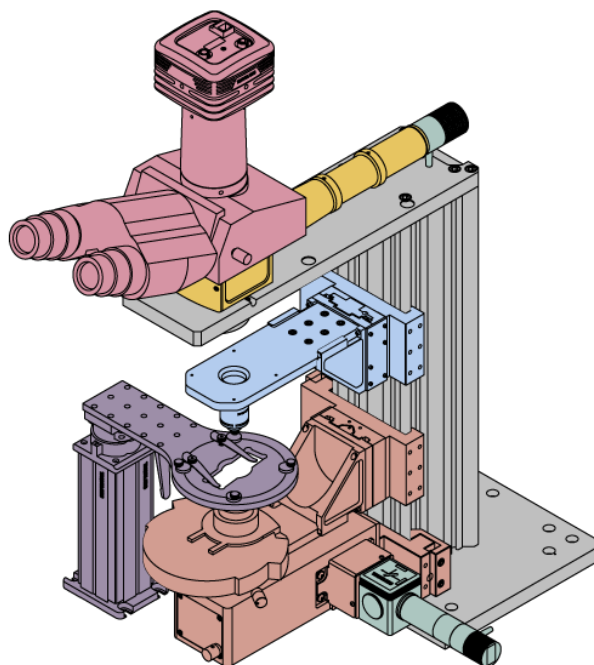

Terminology

Arm: Holds components in the optical path of the microscope.

Bayonet Mount: A form of mechanical attachment with tabs on the male end that fit into L-shaped slots on the female end.

Bellows: A tube with accordion-shaped rubber sides for a flexible, light-tight extension between the microscope body and the objective.

Breadboard: A flat structure with regularly spaced tapped holes for DIY construction.

Dovetail: A form of mechanical attachment for many microscopy components. A linear dovetail allows flexible positioning along one dimension before being locked down, while a circular dovetail secures the component in one position. See the *Microscope Dovetails* tab or here for details.

Epi-Illumination: Illumination on the same side of the sample as the viewing apparatus. Epi-fluorescence, reflected light, and confocal microscopy are some examples of imaging modalities that utilize epi-illumination.

Filter Cube: A cube that holds filters and other optical elements at the correct orientations for microscopy. For example, filter cubes are essential for fluorescence microscopy and reflected light microscopy.

Köhler Illumination: A method of illumination that utilizes various optical elements to defocus and flatten the intensity of light across the field of view in the sample plane. A condenser and light collimator are necessary for this technique.

Nosepiece: A type of arm used to hold the microscope objective in the optical path of the microscope.

Optical Path: The path light follows through the microscope.

Rail Height: The height of the support rail of the microscope body.

Throat Depth: The distance from the vertical portion of the optical path to the edge of the support rail of the microscope body. The size of the throat depth, along with the working height, determine the working space available for microscopy.

Trans-Illumination: Illumination on the opposite side of the sample as the viewing apparatus. Brightfield, differential interference contrast (DIC), Dodt gradient contrast, and darkfield microscopy are some examples of imaging modalities that utilize trans-illumination.

Working Height: The height of the support rail of the microscope body plus the height of the base. The size of the working height, along with the throat depth, determine the working space available for microscopy.

Microscope Body

The microscope body provides the foundation of any Cerna microscope. The support rail utilizes 95 mm rails machined to a high angular tolerance to ensure an aligned optical path and perpendicularity with the optical table. The support rail height chosen (350 - 600 mm) determines the vertical range available for experiments and microscopy components. The 7.74" throat depth, or distance from the optical path to the support rail, provides a large working space for experiments. Components attach to the body by way of either a linear dovetail on the support rail, or a circular dovetail on the epi-illumination arm (on certain models). Please see the *Microscope Dovetails* tab or here for further details.

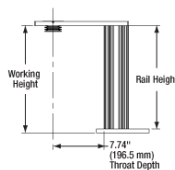

Click to Enlarge Body Details

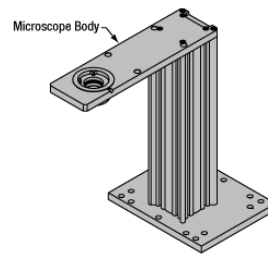

Enlarge Cerna Microscope Body

Click to

Microscope Bodies	Microscope Translator

Illumination

Using the Cerna microscope body, a sample can be illuminated in two directions: from above (epi-illumination, see yellow components to the right) or from below (trans-illumination, see orange components to the right).

Epi-illumination illuminates on the same side of the sample as the viewing apparatus; therefore, the light from the illumination source (green) and the light from the sample plane share a portion of the optical path. It is used in fluorescence, confocal, and reflected light microscopy. Epi-illumination modules, which direct and condition light along the optical path, are attached to the epi-illumination arm of the microscope body via a circular D1N dovetail (see the *Microscope Dovetails* tab or here for details). Multiple epi-illumination modules are available, as well as breadboard tops, which have regularly spaced tapped holes for custom designs.

Trans-illumination illuminates from the opposite side of the sample as the viewing apparatus. Example imaging modalities include brightfield, differential interference contrast (DIC), Dodt gradient contrast, oblique, and darkfield microscopy. Trans-illumination modules, which condition light (on certain models) and direct it along the optical path, are attached to the support rail of the microscope body via a linear dovetail (see *Microscope Dovetails* tab or here). Please note that certain imaging modalities will require additional optics to alter the properties of the beam; these optics may be easily incorporated in the optical path via lens tubes and cage systems. In addition, Thorlabs offers condensers, which reshape input collimated light to help create optimal Köhler illumination. These attach to a mounting arm, which holds the condenser at the throat depth, or the distance from the optical path to the support rail. The arm attaches to a focusing module, used for aligning the condenser with respect to the sample and trans-illumination module.

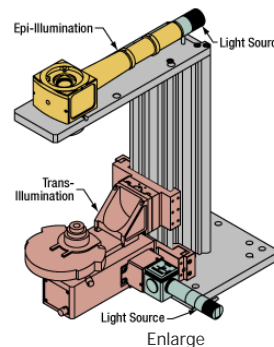

Click to Enlarge Illumination with a Cerna microscope can come from above (yellow) or below (orange). Illumination sources (green) attach to either.

Epi-Illumination Modules	Breadboards & Body Attachments	Brightfield	DIC	Dodt	Condensers	Condenser Mounting	Light Sources

Sample Viewing/Recording

Once illuminated, examining a sample with a microscope requires both focusing on the sample plane (see blue components to the right) and visualizing the resulting image (see pink components).

A microscope objective collects and magnifies light from the sample plane for imaging. On the Cerna

microscope, the objective is threaded onto a nosepiece, which holds the objective at the throat depth, or the distance from the optical path to the support rail of the microscope body. This nosepiece is secured to a motorized focusing module, used for focusing the objective as well as for moving it out of the way for sample handling. To ensure a light-tight path from the objective, the microscope body comes with a bellows (not pictured).

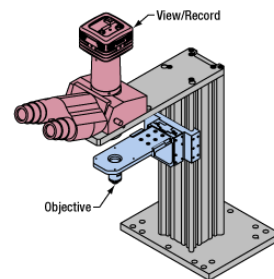

Click to

Enlarge

Light from the sample plane is collected through an objective (blue) and viewed using trinocs or other optical ports (pink).

Various modules are available for sample viewing and data collection. Trinoculars have three points of vision to view the sample directly as well as with a camera. Double camera ports redirect or split the optical path among two viewing channels. Camera tubes increase or decrease the image magnification. For data collection, Thorlabs offers both cameras and photomultiplier tubes (PMTs), the latter being necessary to detect fluorescence signals for confocal microscopy. Breadboard tops provide functionality for custom-designed data collection setups. Modules are attached to the microscope body via a circular dovetail (see the *Microscope Dovetails* tab or here for details).



Sample/Experiment Mounting

Various sample and equipment mounting options are available to take advantage of the large working space of this microscope system. Large samples and ancillary equipment can be mounted via mounting platforms, which fit around the microscope body and utilize a breadboard design with regularly spaced tapped through holes. Small samples can be mounted on rigid stands (for example, see the purple component to the right), which have holders for different methods of sample preparation and data collection, such as slides, well plates, and petri dishes. For more traditional sample mounting, slides can also be mounted directly onto the microscope body via a manual XY stage. The rigid stands can translate by way of motorized stages (sold separately), while the mounting platforms contain built-in mechanics for motorized or manual translation. Rigid stands can also be mounted on top of the mounting platforms for independent and synchronized movement of multiple instruments, if you are interested in performing experiments simultaneously during microscopy.

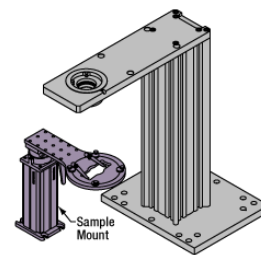

Click to

Enlarge

The rigid stand (purple) pictured is one of various sample mounting options available.

Close



For sample viewing, Thorlabs offers trinoculars, double camera ports, and camera tubes. Light from the sample plane can be collected via cameras, photomultiplier tubes (PMTs), or custom setups using breadboard tops. Click here for additional information about viewing samples with a Cerna microscope.

Product Families & Web Presentations

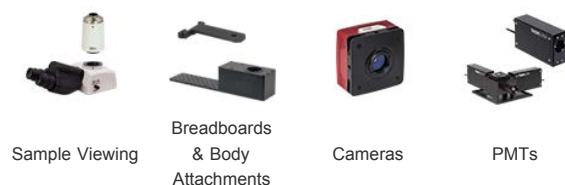

Close

Microscope objectives are held in the optical path of the microscope via a nosepiece. Click here for additional information about viewing a sample with a Cerna microscope.

Product Families & Web Presentations



Objectives



Objective Thread Adapters



Parfocal Length Extender



Piezo Objective Scanner



Objective Mounting

Close

Large and small experiment mounting options are available to take advantage of the large working space of this microscope. Click here for additional information about mounting a sample for microscopy.

Product Families & Web Presentations



Translating Platforms



Rigid Stands



Translation Stages for Rigid Stands



Motorized XY Stages



Manual XY Stage

Close

Thorlabs offers various light sources for epi- and trans-illumination. Please see the full web presentation of each to determine its functionality within the Cerna microscopy platform.

Product Families & Web Presentations



Trans-Illumination Kits



Solis™ High-Power LEDs



Mounted LEDs



X-Cite® Lamps



Other Light Sources

Close

Epi-illumination illuminates the sample on the same side as the viewing apparatus. Example imaging modalities include fluorescence, confocal, and reflected light microscopy. Click here for additional information on epi-illumination with Cerna.

Product Families & Web Presentations



Epi-Illumination



Body Attachments



Light Sources

Close

Trans-illumination illuminates from the opposite side of the sample as the viewing apparatus. Example imaging modalities include brightfield, differential interference contrast (DIC), Dodt gradient contrast, oblique, and darkfield microscopy. Click here for additional information on trans-illumination with Cerna.

Product Families & Web Presentations



Brightfield

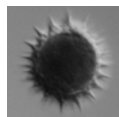

DIC

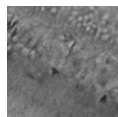

Dodt



Condensers



Condenser Mounting



Illumination Kits



Other Light Sources

Close

The microscope body provides the foundation of any Cerna microscope. The 7.74" throat depth provides a large working space for experiments. Click here for additional information about the Cerna microscope body.

Product Families & Web Presentations



[Hide Preconfigured Cerna™ Microscope](#)

Preconfigured Cerna™ Microscope

The CM1002 Cerna™ Microscope includes all components shown in the *Shipping List* tab.

Part Number	Description	Price	Availability
CM1002	Cerna Microscope with Six-Cube Epi-Illuminator	\$11,485.69	Lead Time

[Hide Cerna™ Microscope Components for Customized Configurations](#)

Cerna™ Microscope Components for Customized Configurations

To tailor the CM1002 Cerna microscope to your imaging needs, its components can be added all at once to the shopping cart using the "Add Kit" button at the bottom of the ordering area, or individually using the shopping cart icon next to each item. Items may be removed from the default item list by changing the value in the "Qty" box to 0 before clicking the "Add Kit" button. This allows our modular microscope components to be used to adapt the microscope to the needs of the particular experiment. A discount is offered when a sufficient number of components are purchased, as reflected in the price of the CM1002. Please see the *Shipping List* tab for additional information about each component in the CM1002 microscope.

Part Number	Description	Price	Availability
CEA1350	Cerna Microscope Body with Epi-Illumination Arm, 350 mm Rail	\$828.00	Today
WFA4000	Trinoculars with 10X Eyepieces, Inverted Image, IR Filter	\$2,915.00	Today
WFA4105	1X Camera Tube with C-Mount, Male D2N Dovetail	\$395.00	Today
CSE1000	Epi-Illuminator Module for Up to 6 Filter Cubes, Male & Female D1N Dovetails	\$2,833.00	Today
CSA1100	Nosepiece for 1 Objective, M32 x 0.75 Threads, 60 mm Cage Compatible	\$174.00	Today
ZFM2020	Motorized Module with 1" Travel for Edge-Mounted Arms	\$1,726.00	Lead Time
MCM3001	Three-Channel Controller and Knob Box for 1" Cerna Travel Stages	\$3,113.00	3-5 Days

Visit the *Cerna™ Microscope with Six-Cube Epi-Illuminator* page for pricing and availability information:
https://www.thorlabs.com/newgrouppage9.cfm?objectgroup_id=8939