

## CM3003 - April 18, 2017

Item # CM3003 was discontinued on April 18, 2017. For informational purposes, this is a copy of the website content at that time and is valid only for the stated product.

### CERNA MICROSCOPE FOR EPI-FLUORESCENCE AND DIC WITH XY PLATFORM

- ▶ Equipped with XY Platform, Six-Cube Epi-Illuminator, and DIC Imaging Module
- ▶ Ready to Accept Objectives, Cameras, Filters, and Illumination Sources

Modular and Configurable



**CM3003**  
Cerna Microscope  
(Optical Table Not Included)

[Hide Overview](#)

#### OVERVIEW

##### Features

- XY Platform Translates Large Apparatuses Over 2" Range in Both X and Y
- Six-Cube Epi-Illuminator and DIC Module Support Visible and NIR Imaging
  - Epi-Illuminator Accepts Lamps with Ø3 mm Liquid Light Guides or Broad-Spectrum LED Lamp
  - DIC Module Includes Visible and NIR LEDs
- Large and Open Working Space Underneath the Objective
  - Ideal for Sample Apparatuses, Recording Chambers, and Micromanipulators
- Compatible with Thorlabs' and Major Manufacturers' Objectives, Scientific Cameras, Fluorescence Filters, and Illumination Sources
- Modular Design for Tweaking and Modifying the Microscope's Optical Path

The CM3003(M) Cerna Microscope provides a preconfigured optical path for experiments that would benefit from the ability to construct large apparatuses around the optical path and translate them once assembled. It is highlighted by our XY platform, which provides a 24" x 18" (600 mm x 450 mm) surface with 1/4"-20 (M6 x 1.0) tapped holes that translates over a 2" range in both X and Y. This large surface offers access to the optical path from the front and the sides, which is ideal for positioning micromanipulators or rigid stand sample holders. In addition, this microscope includes a DIC imaging and brightfield module with visible and near-infrared (NIR) LEDs for illumination, allowing the user to place micropipettes very accurately with the aid of NIR DIC, then use visible fluorescence to monitor physiological changes without having to relocate the region of interest (ROI).

A dual-objective nosepiece, compatible with M25 x 0.75-threaded objectives, lets you locate an ROI using a low-magnification objective and then image using a high-magnification objective. Motorized objective and condenser focusing modules, each with 1" of travel, enable fine tuning of the epi- and trans-illumination conditions. A six-cube epi-illumination module is ideal for targeting spectrally separated fiducial markers, and together with the DIC module provides easily co-registered fluorescence and DIC images of the field of view. We have also equipped the microscope with a variable-magnification double camera port that lets two cameras be individually dedicated to reflected light imaging, epi-fluorescence, DIC, or other specific imaging modalities.

Unlike competing microscopes with similar capabilities, the Cerna platform's modularity lets the user quickly install and remove the microscope modules as needed for each experiment, providing a high degree of access and control. For example, when the trans-illumination modules are installed, *in vitro* samples can be studied using epi-fluorescence and DIC imaging, as well as with basic widefield and brightfield illumination. To free room underneath the objective for large sample holding apparatuses, the trans-illumination modules can be removed, providing a path for *in vivo* studies.

To address a wide range of experimental parameters, Thorlabs offers eight preconfigured Cerna microscopes, which are summarized in the table below. In addition, we can work with you to configure a microscope that meets your unique needs. To contact our team, please e-mail [ImagingSales@thorlabs.com](mailto:ImagingSales@thorlabs.com). We also offer Cerna components individually for customers interested in building their own microscope.



Click to Enlarge  
Side View of CM3003 Cerna  
Microscope  
(Optical Table is Sold Separately)

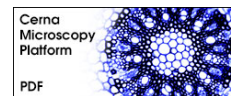

Cerna Microscopes	CM1001	CM1002	CM1003	CM2001	CM2002	CM3001	CM3002	CM3003(M)
Objective Holder	Single	Single	Single	Dual	Dual	Dual	Dual	Dual
Epi-Illumination	1 Cube	Up to 6 Cubes	1 Cube	Up to 6 Cubes	Up to 6 Cubes	Up to 6 Cubes	Up to 6 Cubes	Up to 6 Cubes
Trans-Illumination	-	-	Brightfield (Visible)	Brightfield (Visible)	Dot Contrast and Brightfield (Visible)	Dot Contrast and Brightfield (Visible and NIR)	DIC Imaging and Brightfield (Visible and NIR)	DIC Imaging and Brightfield (Visible and NIR)
XY Motion	-	-	-	-	-	Microscope Translator	-	Translating Platform

[Hide Microscope Design](#)

## MICROSCOPE DESIGN

Entirely constructed from our line of modular components, this Cerna microscope includes several convenient features for imaging, which are highlighted below. The *Accessories* tab shows our offering of objectives, scientific-grade cameras, fluorescence filters, and illumination sources that are ideal for customizing this model to your experiment. The *Shipping List* tab gives the components used in this microscope, as well as a link to each component's webpage, where additional information (such as mechanical drawings) is available.

### Epi-Illumination

#### Features

- Six-Cube Epi-Illuminator Module (Filter Cubes and Filter Sets are Sold Separately)
- Compatible Illumination Sources
  - HPLS343 Liquid Light Guide Lamp (Requires LLG3A5-A Adapter)
  - XCITE200DC Liquid Light Guide Lamp
  - Any Other Illumination Source with Nikon Bayonet Mount

### Add-Ons: Epi-Illumination

- Illumination Sources
  - High-Power Light Source with Liquid Light Guide (Requires LLG3A5-A Adapter)
  - X-Cite Lamps
- Epi-Fluorescence Filter Cubes
- Epi-Fluorescence Filter Sets

The microscope is able to target multiple fluorescence channels through the use of the six-cube epi-illuminator. A standard Nikon bayonet mount on the rear of the microscope accepts a wide range of white-light lamps. The intensity of the illumination at the sample can be adjusted using the three neutral density (ND) filters mounted in black sliders at the back of the housing.



[Click to Enlarge](#)

The filter cubes are protected by a door in front of the rotating turret. Neutral density filters in black sliders on the left side of the module adjust the illumination intensity at the sample.



[Click to Enlarge](#)

The rotating turret accommodates up to six filter cubes. Each turret position has a yellow label.



[Click to Enlarge](#)

White light illumination sources are attached using the bayonet mount on the back of the microscope.

### Trans-Illumination (DIC Imaging)

#### Features

- Supports DIC Imaging and Brightfield Illumination in the Visible and NIR
- Motorized Condenser Focusing Module with 1" Travel
- 0.78 NA Nikon Condenser

This microscope includes the specific Cerna components that are needed to perform DIC imaging, which include the six-cube epi-illuminator, a compatible objective holder, and all DIC optics except DIC objective prisms, which are objective-specific. Please see the full web presentation for additional information.



[Click for Details](#)

DIC imaging in the visible and NIR is enabled by the six-cube epi-illuminator module, a DIC-compatible objective holder, and two LEDs. (For clarity, the

The motorized condenser provides fine focusing control over a 1" travel range. Thorlabs offers additional condensers and condenser mounting options to tailor the microscope to individual needs. Bright illumination in the visible and NIR regions of the spectrum is generated by the included illumination kit (Item # WFA1051), which uses Thorlabs' LEDs. Additional LEDs compatible with the illumination kit may be found here.

XY platform is not shown.)

## Motion Control (XY Platform)

### Features

- Move Rigid Stands, Micromanipulators, and Other Experimental Equipment Together Simultaneously
- 2" Travel Range in Both X and Y
- 24" x 18" (600 mm x 450 mm) Surface Area
- 352 Tapped Holes for Securing Equipment
  - Imperial Version: 1/4"-20 Tapped Holes on 1" Centers
  - Metric Version: M6 x 1.0 Tapped Holes on 25 mm Centers



Click to Enlarge  
The XY platform provides a large translating work surface around the microscope's optical path.

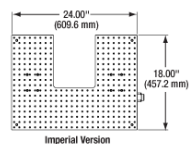

Click for Details  
Drawing of Imperial XY Platform with Holes on 1" Centers

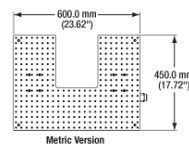

Click for Details  
Drawing of Metric XY Platform with Holes on 25 mm Centers

The low-profile breadboard included with this microscope provides a large 24" x 18" (600 mm x 450 mm) work surface around the microscope body with 2" of linear motorized travel in both X and Y. Any equipment secured to the platform using its 352 1/4"-20 (M6 x 1.0) tapped holes will move together, permitting large-scale, multi-component experimental apparatuses to be translated as one unit with respect to the field of view. Manual translating platforms are also available via the full web presentation.

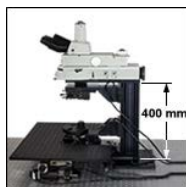

Click to Enlarge  
The vertical support rail holds modules in the optical path and does not block approach angles from the rear of the microscope.

## Microscope Body

### Features

- Large Working Volume: Optical Path is 7.74" (196.5 mm) Away from Edge of Rail
- Linear Dovetail Surface Allows Modules to be Added and Removed
- 400 mm Body Height Provides Space for DIC Imaging Module
- Motorized Objective Focusing Module with 1" Travel
- Mechanically Compatible with Thorlabs' 95 mm Rail Platforms

The 95 mm vertical support rail is the backbone of the Cerna microscope, providing stable long-term support and excellent vibrational damping. Its linear dovetail mounting surface allows modules to be removed when they are not needed, freeing additional workspace and opening the door to user customization. For alternate rail heights, see the full web presentation.



Click to Enlarge  
This microscope includes a double camera port that allows cameras to be individually dedicated to different imaging modalities.

## Widefield Viewing

### Features

- Variable-Magnification Double Camera Port for Independent Visible and NIR Cameras
  - Fixed 1X Magnification for Front Camera
  - Variable 0.35X, 2X, or 4X Magnification for Rear Camera
- Trinoculars with 10X Magnification and Adjustable Interpupil Distance

This part of the microscope visualizes and records sample images in the visible and near-infrared (NIR) regions of the spectrum. Visible light, which is generated by fluorophores and fiducial markers, is directed to the front camera port, while NIR light, which is used in DIC imaging, is directed to the rear camera port. For additional camera port and camera tube options, please see the full web presentation.

## Add-On: Widefield Viewing

- Scientific Cameras

## Objective Holder

### Features

- Use Low Magnification to Find the Region of Interest, then High Magnification to Image
- Compatible with M25 x 0.75-Threaded Objectives (Nikon)

The dual-objective nosepiece offers direct compatibility with M25 x 0.75-threaded objectives. This thread standard is most commonly used by Nikon objectives. For other objective mounting options, please see the full web presentation.

## Add-On: Objectives

- Microscope Objectives



Click to Enlarge  
High-Magnification, M25 x 0.75-Threaded, 40X Objective Being Installed (Objective Not Included)



Click to Enlarge  
Low-Magnification, M25 x 0.75-Threaded, 10X Objective Being Installed (Objectives Not Included)

[Hide Accessories](#)

## ACCESSORIES

### Selected Accessories

In order to image with this microscope, it is necessary to add scientific cameras, an epillumination source, filter cubes and filter sets, objectives, and sample holders. Moreover, it is often possible to improve the quality of your experimental data by carefully selecting

### Application-Optimized Cerna Microscopes

Developed in collaboration with our colleagues in the field, the Cerna microscopy platform is uniquely modular and

[Contact Us](#)

accessories that complement your specific experiment. To that end, we have ensured that Cerna microscopes are compatible with a wide range of accessories. The information below compares the Cerna-compatible components that are manufactured or sold by Thorlabs. We have also indicated when it is possible to use equipment designed by other manufacturers.

**Content**

- Scientific Cameras for Widefield Viewing
- Illumination Sources for Epi-Illumination
- Filter Cubes and Filter Sets for Epi-Fluorescence
- Objectives
- Sample Holders

**Scientific Cameras for Widefield Viewing**

- Visualize the Field of View at a Computer
- Connect Two Cameras for Independent Visible and NIR Imaging
- Any C-Mount Camera is Compatible with a Cerna Microscope

Thorlabs' scientific cameras are optimized for a range of imaging needs. Cameras allow the field of view to be displayed on a computer screen and saved for later reference. Viewing your sample from a computer also enables remote sample positioning using our motion control accessories, allowing samples to be moved in sensitive setups without introducing additional vibrations from your hands.

This Cerna model includes a double camera port that directs visible light to the front camera and near-infrared light to the rear camera. The magnification of the image plane at the front camera is fixed and equal to the objective magnification. The magnification of the image plane at the rear camera is variable and equal to the objective magnification multiplied by 0.35X, 2X, or 4X, as determined by rotating a knob.

Any camera with C-Mount (1.000"-32) threading is compatible with this microscope. The most popular cameras used with Cerna systems are given in the table below. Higher-resolution options can be found in our complete range of scientific cameras.

flexible, making it adaptable to a wide range of demanding experimental requirements. If you would like to work with our application specialists, engineers, and sales team to design your own microscope, please email [ImagingSales@thorlabs.com](mailto:ImagingSales@thorlabs.com).



Click to Enlarge  
The front camera port provides fixed 1X magnification for visible light from the sample, while the rear camera port provides variable magnification of 0.35X, 2X, or 4X for NIR light from the sample.

Item #	DCU224M	340M-USB	1501M-USB
<b>Product Photo</b> (Click to Enlarge)			 Click to Enlarge
<b>Primary Feature</b>	<b>Lightweight</b>	<b>Fast Frame Rate</b>	<b>High Resolution and Dynamic Range</b>
<b>Sensor Type</b>	Sony ICX205AL	On Semi / Truesense KAI-0340 Monochrome CCD	Sony ICX285AL Monochrome CCD (Grade 0)
<b>Sensor Format</b>	1/2" (7.62 mm Diagonal)	1/3" Format (5.92 mm Diagonal)	2/3" Format (11 mm Diagonal)
<b>Resolution</b>	1280 x 1024 Pixels	640 x 480 Pixels	1392 x 1040 Pixels
<b>Pixel Size</b>	4.65 μm x 4.65 μm	7.4 μm x 7.4 μm	6.45 μm x 6.45 μm
<b>Frame Rate (Max)</b>	15 fps	200.7 fps	23 fps
<b>Host PC Interface</b>	USB 2.0 (Cable Included)	USB 3.0 (Cable Included)	
<b>Digital Output</b>	8 Bits	14 Bits	14 Bits
<b>Mass</b>	96 g (0.21 lbs)	750 g (1.65 lbs)	

**Illumination Sources for Epi-Illumination**

- White Light Sources Illuminate the Field of View Through the Objective
- Available Options Include Liquid Light Guide and Broad-Spectrum LED Lamps
- Light is Conditioned by Filter Cubes and Filter Sets for Specific Fluorophores (See Below)

The six-cube epi-illuminator module that is included with this Cerna microscope requires a broadband white light source that emits across the visible region of the spectrum. Broadband emission makes it possible for the same microscope to stimulate fluorophores whose absorption wavelengths are spectrally separated. Several filter sets aimed at common fluorophores are available below.

All three lamps offered by Thorlabs provide emission throughout the visible range, local intensity control from the front panel of the light source, and external intensity control via BNC and/or USB 2.0. They are equipped with a flexible liquid light guide (LLG) that makes it easy to position the lamp around the rest of your equipment.



Click to Enlarge  
Here, a liquid light guide lamp is being connected to the epi-illuminator module via a bayonet-to-LLG adapter.

Any illumination source that can be coupled to a Nikon bayonet mount is compatible with Cerna microscopes. For example, Thorlabs' LLG3A5-A adapter connects any Ø3 mm LLG to a Nikon bayonet mount. We also manufacture lamphouse port adapters that make Nikon bayonet mounts compatible with our Ø1" or Ø2" lens tubes.



Click to Enlarge

### HPLS343 Features

- ▶ Output Spectrum: 350 - 800 nm
- ▶ Intensity is Variable from 0.1% to 100% Using Knob
- ▶ External Control via USB 2.0 or BNC Inputs
- ▶ Lifetime: 10,000 Hours (Average)
- ▶ Includes Ø3 mm, 1.2 m (4') Long LLG
- ▶ Requires LLG3A5-A Collimating Adapter (Sold Separately)
- ▶ Link to Full Web Presentation



Click to Enlarge

### XCITE200DC Features

- ▶ Output Spectrum: 340 - 800 nm
- ▶ Intensity is Variable from 0% to 100% Using Knob
- ▶ External Control via BNC Input
- ▶ Lifetime: >2,000 Hours (Minimum); >2,500 Hours (Typical)
- ▶ Includes Ø3 mm, 5' (1.5 m) Long LLG and Nikon Bayonet Mount
- ▶ Link to Full Web Presentation

### Filter Cubes and Filter Sets for Epi-Fluorescence

- Tune Epi-Illumination Source for the Excitation and Detection of Specific Fluorophores
- Up to Six Filter Cubes can be Installed Simultaneously
- Select Filter Sets Available Pre-Installed in Microscope Filter Cubes
- Cerna Microscopes are Compatible with Fluorescence Filters from All Major Manufacturers
- Additional Filter Sets Available



Click to Enlarge  
TLV-TE2000 Filter Cube  
Accepts: Excitation Filter (Ø25 mm, up to 5 mm Thick), Emission Filter (Ø25 mm, up to 3.5 mm Thick), and Dichroic Mirror (up to 25.2 mm x 36.0 mm x 1.1 mm)

The epi-illumination module included with this microscope can hold up to six TLV-TE2000 filter cubes at once. A hand-operated turret is used to switch between filter cubes.

The filter sets we offer, which consist of an excitation filter, an emission filter, and a dichroic mirror, come in the industry-standard sizes. For excitation and emission filters, the standard dimensions are Ø25 mm, while for dichroic mirrors, the standard dimensions are 25 mm x 36 mm. This allows Cerna microscopes to be compatible with filters from all major manufacturers.

The table to the right lists popular filter sets we offer, as well as the fluorophores they target. Please see the full web presentation for the entire line of Thorlabs' filter sets. If the filter cubes and filter sets are purchased at the same time, we will mount the filter sets in the filter cubes at no additional charge. Please contact Technical Support prior to purchase to take advantage of this service.

Filter Transmission Spectra <sup>a</sup>		
Item #	Target Fluorophore	Transmission Graph (Click for Plot)
MDF-BFP	BFP (Blue Fluorescent Protein)	
MDF-GFP2	Alexa Fluor <sup>®</sup> 488	
MDF-MCHA <sup>b</sup>	mCherry	
MDF-MCHC <sup>c</sup>	mCherry	
MDF-TOM	tdTomato	

- a. Please see the full web presentation for a complete listing of fluorescence filter sets offered.
- b. This filter set's excitation range is centered around 578 nm, making it well matched to typical LEDs.
- c. This filter set's excitation range is centered around 562 nm, making it well matched to typical lamps.

### Objectives

- Microscope Accepts M25 x 0.75-Threaded Objectives (Nikon)
- Matching DIC Objective Prisms (Sold Separately) are Required for DIC
- DIC Polarizers, Condenser Prisms, and Analyzer are Included with Microscope

The nosepiece of this microscope contains M25 x 0.75 threads in two places, allowing it to hold two objectives simultaneously. M25 x 0.75 threads are most commonly used by Nikon objectives. For convenience, we stock several widefield Nikon objectives that are commonly used with Cerna microscopes, shown in the table below on the left. Our in-stock selection is not exhaustive. If you would like to order a different objective, please contact us.







Click to Enlarge  
DIC Optics Included with Microscope  
(DIC Objective Prisms are Not Included)

### DIC Imaging Accessories



In order to perform DIC imaging, the Nikon objective that you pick must be paired with its compatible DIC objective prism. The table below on the right gives the item number of the DIC objective prism you should order. All other necessary optics for DIC (polarizers, condenser prisms, and analyzer) are included with the microscope.

Objective Item #	N4X-PF	N10X-PF	N20X-PF	N40X-PF	N60X-PF
<b>Photo</b> (Click to Enlarge)					
<b>Magnification</b>	4X	10X	20X	40X	60X
<b>Numerical Aperture (NA)</b>	0.13	0.3	0.50	0.75	0.85
<b>Working Distance (WD)</b>	17.2 mm	16 mm	2.1 mm	0.66 mm	0.31 - 0.4 mm
<b>Threading</b>	M25 x 0.75				

DIC Objective Prism Item #	Compatible Objectives
MBH76210	Nikon Plan Fluorite, 10X
MBH76720	Nikon, 16X
MBH76220	Nikon Plan Fluorite, 20X
MBH76225	Nikon, 25X
MBH76240	Nikon Plan Fluorite, 40X
MBH76640	Nikon APO NIR, 40X, Water Immersion
MBH76160	Nikon APO NIR, 60X, Water Immersion

## Sample Holders

- Rigid Stands Hold Samples Underneath and Around the Objective
  - Designed for Slides, Petri Dishes, Well Plates, Recording Chambers, Micromanipulators, and Custom Inserts
  - Translation Stages with 1" of X and Y Travel Available
- Fixed Arms Incorporate Fast XY Stage, Lens Tubes, and/or Cage Systems Directly into Optical Path
  - CSA1000: For Our MLS203-1 Fast XY Scanning Stage
  - CSA1001: For Ø1" Lens Tubes and 30 mm Cage Systems
  - CSA1002: For Ø2" Lens Tubes and 60 mm Cage Systems



Click to Enlarge  
MP100-MLSH Rigid Stand with  
MLS203P2 Slide/Petri Dish  
Holder



Click to Enlarge  
MLS203-1 Stage with  
MLS203P2 Slide Holder on  
CSA1000 Fixed Arm



Click for Details  
MP100-RCH2 Slide Holder in a  
Cerna Microscope

Thorlabs offers highly configurable solutions for mounting your sample beneath the objective of the Cerna microscope. Rigid stands are available with multiple platform styles that can accept slides, petri dishes, well plates, recording chambers, micromanipulators, and custom inserts. The included collar makes them lockable at a height and angle chosen by the user. We also manufacture translation stages for these rigid stands that provide motorized horizontal translation of the sample.

Our fixed arms attach directly to the dovetail that spans the height of the microscope body, allowing them to be positioned anywhere along the body height, putting the sample directly into the microscope's optical path, and taking advantage of the existing footprint of the scope. For a pre-configured sample holder solution, use the CSA1000 Fixed Arm with the MLS203-1 Fast XY Scanning Stage. This stage is compatible with our MZS500-E Piezo-Driven Insert, which adds high-resolution Z-axis adjustments. Alternatively, the CSA1001 and CSA1002 Fixed Arms are compatible with Thorlabs' extensive selection of optomechanical components, allowing custom sample holder configurations to be integrated with the microscope body.

Several compatible options are outlined in the tables below. For our full range of rigid stand inserts and heights, please see their full web presentation.

### Rigid Stands



Click to Enlarge

#### MP150-RCH2 Slide Holder

- ▶ Designed for Standard 3" x 1" (76.2 mm x 25.4 mm) Microscope Slides
- ▶ Height Range: 198.1 - 309.3 mm
- ▶ Other Heights Available



Click to Enlarge

#### MP150-MLSH Insert Holder

- ▶ Designed for Multiple Slides, Petri Dishes, Well Plates, Calibration Targets, Breadboards, Our MZS500-E Z-Axis Piezo Stage, and User-Designed Inserts
- ▶ Height Range: 198.1 - 309.3 mm
- ▶ Other Heights Available



Click to Enlarge

#### MP150-RCH1 Recording Chamber Holder

- ▶ Circular Hole Designed for Recording Chambers
- ▶ Height Range: 198.1 - 309.3 mm
- ▶ Other Heights Available



Click to Enlarge

#### MP150 Rigid Stand with Platform

- ▶ 24 M6 x 1.0 Tapped Holes for Holding Micromanipulators or Other Equipment
- ▶ Height Range: 198.1 - 309.3 mm
- ▶ Other Heights Available

### Fixed Arms



Click to Enlarge  
**CSA1000 Fixed Arm**  
 ▶ Accepts MLS203-1 Fast XY Scanning Stage



Click to Enlarge  
**CSA1001 Fixed Arm**  
 ▶ Compatible with Ø1" Lens Tubes and 30 mm Cage Systems



Click to Enlarge  
**CSA1002 Fixed Arm**  
 ▶ Compatible with Ø2" Lens Tubes and 60 mm Cage Systems

[Hide Shipping List](#)

## SHIPPING LIST

The microscope on this webpage is entirely constructed from our selection of modular Cerna components. This tab lists all of the components that the microscope contains.

Item #	Qty.	Description	Photo (Click to Enlarge)
<b>Microscope Body</b>			
CEA1400	1	Cerna Microscope Body with Epi-Illumination Arm, 400 mm Tall	
<b>Widefield Viewing</b>			
WFA4000	1	Trinoculars with 10X Eyepieces	
WFA4105	1	1X Camera Tube with C-Mount	
CSD1001	1	Variable Magnification Double Camera Port	
<b>Epi-Illumination</b>			
CSE1000	1	Epi-Illuminator Module for Six Filter Cubes (Filter Cubes Not Included)	
<b>Translating Platform</b>			
PMP-2XY or PMP-2XY/M	1	Translating Platform with 2" Travel in Both X and Y (PMP-2XY has 1/4"-20 Tapped Holes; PMP-2XY/M has M6 x 1.0 Tapped Holes)	
MCM3002	1	3-Axis Controller for Translation, 2" Travel	
<b>Condenser</b>			
CSC1001	1	Nikon FN-C LWD Condenser, 0.78 NA	
<b>Objective &amp; Condenser Mounting</b>			
CSN1202	1	Dual-Objective Nosepiece	
CSA1200	1	Mounting Arm for CSN1202 Nosepiece	

BSA2000	1	Compact Condenser Mounting Arm with $\pm 2.5$ mm Travel in X and Y	
ZFM2020	2	Motorized Focusing Module with 1" Travel	
MCM3001	1	3-Axis Controller for Focus Control, 1" Travel	
<b>Trans-Illumination: DIC Imaging</b>			
WFA1000	1	Brightfield Illumination / DIC Imaging Module	
WFA0150	1	Transmitted Light Module Dovetail Clamp	
WFA3100	1	Polarizer Turret	
WFA3000	1	DIC Polarizer Turret Adapter	
WFA3120	1	Visible DIC Polarizer	
WFA3121	1	IR DIC Polarizer	
WFA3130	1	DIC Prism for 10X Objectives, N1 Dry Condenser	
WFA3131	1	DIC Prism for 16X - 100X Objectives, N2 Dry Condenser	
WFA3110	1	Visible and IR DIC Analyzer	
<b>Illumination Kit</b>			
WFA1051	1	Visible and NIR Illumination Kit	
LEDD1B	2	T-Cube LED Driver	
KPS101	2	15 V Power Supply Unit for a Single K-Cube or T-Cube	

[Hide Microscope Guide](#)

## MICROSCOPE GUIDE

### Elements of a Microscope

This overview was developed to provide a general understanding of a Cerna microscope. Click on the different portions of the microscope graphic to the right or use the links below to learn how a Cerna microscope visualizes a sample.

- Terminology
- Microscope Body
- Illumination

Click on the different parts of the microscope to explore their functions.



- Sample Viewing/Recording
- Sample/Experiment Mounting

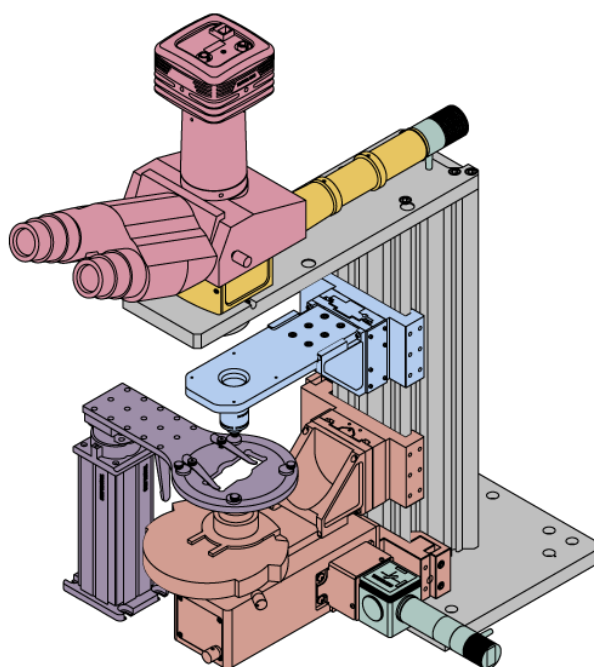

## Terminology

**Arm:** Holds components in the optical path of the microscope.

**Bayonet Mount:** A form of mechanical attachment with tabs on the male end that fit into L-shaped slots on the female end.

**Bellows:** A tube with accordion-shaped rubber sides for a flexible, light-tight extension between the microscope body and the objective.

**Breadboard:** A flat structure with regularly spaced tapped holes for DIY construction.

**Dovetail:** A form of mechanical attachment for many microscopy components. A linear dovetail allows flexible positioning along one dimension before being locked down, while a circular dovetail secures the component in one position. See the *Microscope Dovetails* tab or [here](#) for details.

**Epi-Illumination:** Illumination on the same side of the sample as the viewing apparatus. Epi-fluorescence, reflected light, and confocal microscopy are some examples of imaging modalities that utilize epi-illumination.

**Filter Cube:** A cube that holds filters and other optical elements at the correct orientations for microscopy. For example, filter cubes are essential for fluorescence microscopy and reflected light microscopy.

**Köhler Illumination:** A method of illumination that utilizes various optical elements to defocus and flatten the intensity of light across the field of view in the sample plane. A condenser and light collimator are necessary for this technique.

**Nosepiece:** A type of arm used to hold the microscope objective in the optical path of the microscope.

**Optical Path:** The path light follows through the microscope.

**Rail Height:** The height of the support rail of the microscope body.

**Throat Depth:** The distance from the vertical portion of the optical path to the edge of the support rail of the microscope body. The size of the throat depth, along with the working height, determine the working space available for microscopy.

**Trans-Illumination:** Illumination on the opposite side of the sample as the viewing apparatus. Brightfield, differential interference contrast (DIC), Dot gradient contrast, and darkfield microscopy are some examples of imaging modalities that utilize trans-illumination.

**Working Height:** The height of the support rail of the microscope body plus the height of the base. The size of the working height, along with the throat depth, determine the working space available for microscopy.

## Microscope Body

The microscope body provides the foundation of any Cerna microscope. The support rail utilizes 95 mm rails machined to a high angular tolerance to ensure an aligned optical path and perpendicularity with the optical table. The support rail height chosen (350 - 600 mm) determines the vertical range available for experiments and microscopy components. The 7.74" throat depth, or distance from the optical path to the support rail, provides a large working space for experiments. Components attach to the body by way of either a linear dovetail on the support rail, or a circular dovetail on the epi-illumination arm (on certain models). Please see the *Microscope Dovetails* tab or [here](#) for further details.

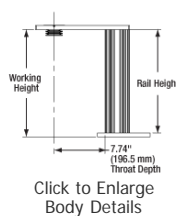

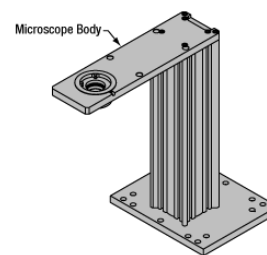

Click to Enlarge  
Body Details



Enlarge  
Cerna Microscope Body

Click to

	
Microscope Bodies	Microscope Translator

### Illumination

Using the Cerna microscope body, a sample can be illuminated in two directions: from above (epi-illumination, see yellow components to the right) or from below (trans-illumination, see orange components to the right).

Epi-illumination illuminates on the same side of the sample as the viewing apparatus; therefore, the light from the illumination source (green) and the light from the sample plane share a portion of the optical path. It is used in fluorescence, confocal, and reflected light microscopy. Epi-illumination modules, which direct and condition light along the optical path, are attached to the epi-illumination arm of the microscope body via a circular D1N dovetail (see the *Microscope Dovetails* tab or here for details). Multiple epi-illumination modules are available, as well as breadboard tops, which have regularly spaced tapped holes for custom designs.

Trans-illumination illuminates from the opposite side of the sample as the viewing apparatus. Example imaging modalities include brightfield, differential interference contrast (DIC), Dordt gradient contrast, oblique, and darkfield microscopy. Trans-illumination modules, which condition light (on certain models) and direct it along the optical path, are attached to the support rail of the microscope body via a linear dovetail (see *Microscope Dovetails* tab or here). Please note that certain imaging modalities will require additional optics to alter the properties of the beam; these optics may be easily incorporated in the optical path via lens tubes and cage systems. In addition, Thorlabs offers condensers, which reshape input collimated light to help create optimal Köhler illumination. These attach to a mounting arm, which holds the condenser at the throat depth, or the distance from the optical path to the support rail. The arm attaches to a focusing module, used for aligning the condenser with respect to the sample and trans-illumination module.

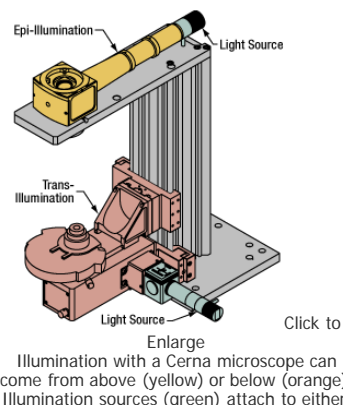

							
Epi-Illumination Modules	Breadboards & Body Attachments	Brightfield	DIC	Dordt	Condensers	Condenser Mounting	Light Sources

### Sample Viewing/Recording

Once illuminated, examining a sample with a microscope requires both focusing on the sample plane (see blue components to the right) and visualizing the resulting image (see pink components).

A microscope objective collects and magnifies light from the sample plane for imaging. On the Cerna microscope, the objective is threaded onto a nosepiece, which holds the objective at the throat depth, or the distance from the optical path to the support rail of the microscope body. This nosepiece is secured to a motorized focusing module, used for focusing the objective as well as for moving it out of the way for sample handling. To ensure a light-tight path from the objective, the microscope body comes with a bellows (not pictured).

Various modules are available for sample viewing and data collection. Trinoculars have three points of vision to view the sample directly as well as with a camera. Double camera ports redirect or split the optical path among two viewing channels. Camera tubes increase or decrease the image magnification. For data collection, Thorlabs offers both cameras and photomultiplier tubes (PMTs), the latter being necessary to detect fluorescence signals for confocal microscopy. Breadboard tops provide functionality for custom-designed data collection setups. Modules are attached to the microscope body via a circular dovetail (see the *Microscope Dovetails* tab or here for details).

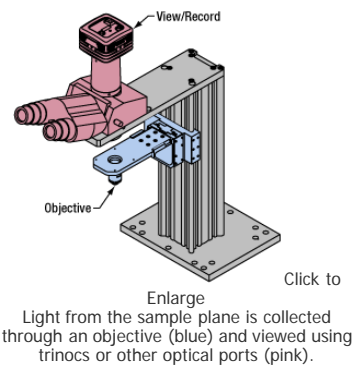

					
Objectives & Accessories	Objective Mounting	Sample Viewing	Cameras	PMTs	Breadboards & Body Attachments

### Sample/Experiment Mounting

Various sample and equipment mounting options are available to take advantage of the large working space of this microscope system. Large samples and ancillary equipment can be mounted via mounting platforms, which fit around the microscope body and utilize a breadboard design with regularly spaced tapped through holes. Small samples can be mounted on rigid stands (for example, see the purple component to the right), which have holders for different methods of sample preparation and data collection, such as slides, well plates, and petri dishes. For more traditional sample mounting, slides can also be mounted directly onto the microscope body via a manual XY stage. The rigid stands can translate by way of motorized stages (sold separately), while the mounting platforms contain built-in mechanics for motorized or manual translation. Rigid stands can also be mounted on top of the mounting platforms for independent and synchronized movement of multiple instruments, if you are interested in performing experiments simultaneously during microscopy.

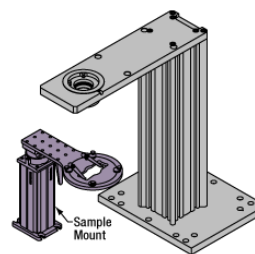

Click to Enlarge  
The rigid stand (purple) pictured is one of various sample mounting options available.

Close

				
Translating Platforms	Rigid Stands	Translation Stages for Rigid Stands	Motorized XY Stages	Manual XY Stage

For sample viewing, Thorlabs offers trinoculars, double camera ports, and camera tubes. Light from the sample plane can be collected via cameras, photomultiplier tubes (PMTs), or custom setups using breadboard tops. Click here for additional information about viewing samples with a Cerna microscope.

Product Families & Web Presentations



Close

Microscope objectives are held in the optical path of the microscope via a nosepiece. Click here for additional information about viewing a sample with a Cerna microscope.

Product Families & Web Presentations

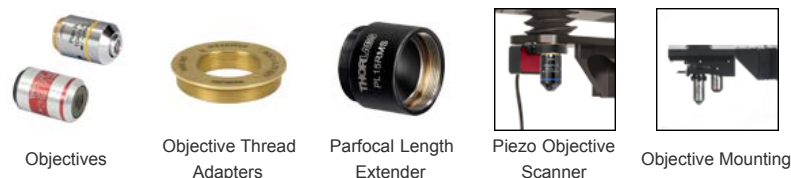

Close

Large and small experiment mounting options are available to take advantage of the large working space of this microscope. Click here for additional information about mounting a sample for microscopy.

Product Families & Web Presentations



Close

Thorlabs offers various light sources for epi- and trans-illumination. Please see the full web presentation of each to determine its functionality within the Cerna microscopy platform.

Product Families & Web Presentations



Close

Epi-illumination illuminates the sample on the same side as the viewing apparatus. Example imaging modalities include fluorescence, confocal, and reflected light microscopy. Click here for additional information on epi-illumination with Cerna.

Product Families & Web Presentations



Close

Trans-illumination illuminates from the opposite side of the sample as the viewing apparatus. Example imaging modalities include brightfield, differential interference contrast (DIC), Dodt gradient contrast, oblique, and darkfield microscopy. Click here for additional information on trans-illumination with Cerna.

Product Families & Web Presentations

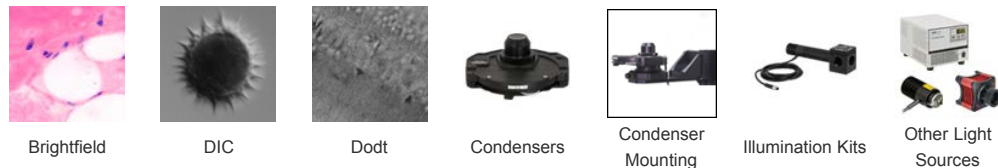

Close

The microscope body provides the foundation of any Cerna microscope. The 7.74" throat depth provides a large working space for experiments. Click here for additional information about the Cerna microscope body.

Product Families & Web Presentations



[Hide Preconfigured Cerna Microscope](#)

**Preconfigured Cerna Microscope**

The CM3003(/M) Cerna Microscope includes all components shown in the *Shipping List* tab.

Part Number	Description	Price	Availability
CM3003/M	Cerna Microscope for Epi-Fluorescence and DIC with Metric XY Platform	\$56,741.81	Lead Time
CM3003	Cerna Microscope for Epi-Fluorescence and DIC with Imperial XY Platform	\$56,741.81	Lead Time

[Hide Cerna Microscope Components for Customized Configurations - Imperial](#)

**Cerna Microscope Components for Customized Configurations - Imperial**

To tailor the CM3003 Cerna microscope to your imaging needs, its components can be added all at once to the shopping cart using the "Add Kit" button at the

bottom of the ordering area, or individually using the shopping cart icon next to each item. Items may be removed from the default item list by changing the value in the "Qty" box to 0 before clicking the "Add Kit" button. This allows our modular microscope components to be used to adapt the microscope to the needs of the particular experiment. A discount is offered when a sufficient number of components are purchased, as reflected in the price of the CM3003. Please see the *Shipping List* tab for additional information about each component in the CM3003 microscope.

Please note that our translating platform comes in both imperial and metric versions.

Part Number	Description	Price	Availability
CEA1400	Cerna Microscope Body with Epi-Illumination Arm, 400 mm Rail	\$837.00	Today
WFA4000	Trinoculars with 10X Eyepieces, Inverted Image, IR Filter	\$2,915.00	Today
WFA4105	1X Camera Tube with C-Mount, Male D2N Dovetail	\$395.00	Today
CSD1001	Variable Magnification Double Camera Port	\$8,519.00	Today
CSE1000	Epi-Illuminator Module for Up to 6 Filter Cubes, Male & Female D1N Dovetails	\$2,833.00	Today
MCM3002	Three-Channel Controller and Knob Box for 2" Cerna Travel Stages	\$3,598.00	Today
CSC1001	Nikon FN-C LWD Condenser, 0.78 NA, Male D3N Dovetail	\$1,987.00	Today
CSN1202	Nosepiece for 2 Objectives, M25 x 0.75 Threads	\$1,832.00	Today
CSA1200	Mounting Arm for CSN1201 and CSN1202 Nosepieces	\$199.00	Today
BSA2000	Condenser Arm, ±2.5 mm Travel per Adjuster, Female D3N Dovetail	\$692.00	Today
ZFM2020	Motorized Module with 1" Travel for Edge-Mounted Arms	\$1,726.00	Lead Time
MCM3001	Three-Channel Controller and Knob Box for 1" Cerna Travel Stages	\$3,113.00	3-5 Days
WFA1000	Transmitted Light Illumination / DIC Imaging Module, 30 mm Cage Compatible	\$4,150.00	Today
WFA0150	95 mm Dovetail Clamp for WFA1000 and WFA1100 Modules	\$265.00	Today
WFA3100	Polarizer Turret	\$1,377.00	Today
WFA3000	DIC Polarizer Turret Mounting Adapter	\$211.00	Today
WFA3120	Visible DIC Polarizer	\$1,377.00	Today
WFA3121	IR DIC Polarizer	\$2,067.00	Today
WFA3130	DIC Condenser Prism for N1 Objectives	\$1,372.00	Today
WFA3131	DIC Condenser Prism for N2 Objectives	\$1,372.00	Today
WFA3110	Visible and IR DIC Analyzer	\$1,297.00	Today
WFA1051	Warm White and IR Illumination Kit	\$1,838.00	Today
LEDD1B	T-Cube LED Driver, 1200 mA Max Drive Current (Power Supply Not Included)	\$299.00	Today
KPS101	15 V, 2.4 A Power Supply Unit for One K-Cube or T-Cube	\$26.25	Today
PMP-2XY	Motorized Translating XY Platform, 1/4"-20 Taps	\$12,211.72	Today

[Hide Cerna Microscope Components for Customized Configurations - Metric](#)

### Cerna Microscope Components for Customized Configurations - Metric

To tailor the CM3003/M Cerna microscope to your imaging needs, its components can be added all at once to the shopping cart using the "Add Kit" button at the bottom of the ordering area, or individually using the shopping cart icon next to each item. Items may be removed from the default item list by changing the value in the "Qty" box to 0 before clicking the "Add Kit" button. This allows our modular microscope components to be used to adapt the microscope to the needs of the particular experiment. A discount is offered when a sufficient number of components are purchased, as reflected in the price of the CM3003/M. Please see the *Shipping List* tab for additional information about each component in the CM3003/M microscope.

Please note that our translating platform comes in both imperial and metric versions.

Part Number	Description	Price	Availability
PMP-2XY/M	Motorized Translating XY Platform, M6 x 1.0 Taps	\$12,211.72	Today
CEA1400	Cerna Microscope Body with Epi-Illumination Arm, 400 mm Rail	\$837.00	Today
WFA4000	Trinoculars with 10X Eyepieces, Inverted Image, IR Filter	\$2,915.00	Today
WFA4105	1X Camera Tube with C-Mount, Male D2N Dovetail	\$395.00	Today
CSD1001	Variable Magnification Double Camera Port	\$8,519.00	Today
CSE1000	Epi-Illuminator Module for Up to 6 Filter Cubes, Male & Female D1N Dovetails	\$2,833.00	Today
CSN1202	Nosepiece for 2 Objectives, M25 x 0.75 Threads	\$1,832.00	Today
CSA1200	Mounting Arm for CSN1201 and CSN1202 Nosepieces	\$199.00	Today
MCM3002	Three-Channel Controller and Knob Box for 2" Cerna Travel Stages	\$3,598.00	Today
CSC1001	Nikon FN-C LWD Condenser, 0.78 NA, Male D3N Dovetail	\$1,987.00	Today
ZFM2020	Motorized Module with 1" Travel for Edge-Mounted Arms	\$1,726.00	Lead Time
MCM3001	Three-Channel Controller and Knob Box for 1" Cerna Travel Stages	\$3,113.00	3-5 Days
BSA2000	Condenser Arm, ±2.5 mm Travel per Adjuster, Female D3N Dovetail	\$692.00	Today



WFA1000	Transmitted Light Illumination / DIC Imaging Module, 30 mm Cage Compatible	\$4,150.00	Today
WFA0150	95 mm Dovetail Clamp for WFA1000 and WFA1100 Modules	\$265.00	Today
WFA3100	Polarizer Turret	\$1,377.00	Today
WFA3000	DIC Polarizer Turret Mounting Adapter	\$211.00	Today
WFA3120	Visible DIC Polarizer	\$1,377.00	Today
WFA3121	IR DIC Polarizer	\$2,067.00	Today
WFA3130	DIC Condenser Prism for N1 Objectives	\$1,372.00	Today
WFA3131	DIC Condenser Prism for N2 Objectives	\$1,372.00	Today
WFA3110	Visible and IR DIC Analyzer	\$1,297.00	Today
WFA1051	Warm White and IR Illumination Kit	\$1,838.00	Today
LEDD1B	T-Cube LED Driver, 1200 mA Max Drive Current (Power Supply Not Included)	\$299.00	Today
KPS101	15 V, 2.4 A Power Supply Unit for One K-Cube or T-Cube	\$26.25	Today

Visit the *Cerna Microscope for Epi-Fluorescence and DIC with XY Platform* page for pricing and availability information:  
[https://www.thorlabs.com/newgrouppage9.cfm?objectgroup\\_id=8938](https://www.thorlabs.com/newgrouppage9.cfm?objectgroup_id=8938)