

## DET05D - March 30, 2018

Item # DET05D was discontinued on March 30, 2018. For informational purposes, this is a copy of the website content at that time and is valid only for the stated product.

### HIGH-SPEED PHOTODETECTORS

- ▶ Monitor CW or Fast Pulsed Lasers
- ▶ Detectors for Wavelengths from 150 to 2600 nm
- ▶ Integrate with Cage or Lens Tube Systems

#### Application Idea



Mounted Detectors are Cage System Compatible  
(See the *Housing Features* Tab for Details)



**DET36A**  
Biased Si Detector



**DET10D2**  
Biased InGaAs Detector

[Hide Overview](#)

#### OVERVIEW

##### Features

- 11 Models Cover the 150 nm to 2.6  $\mu\text{m}$  Wavelength Range
- Rise Times as Fast as 1 ns
- Compact Housing for Measurements in Tight Spaces
- SM05 Lens Tube, SM1 Lens Tube, Cage System, and  $\text{\O}1/2$ " Post Compatible
- Internal A23 12 V VDC Bias Battery (Included)
- Can be Fiber Coupled Using Our Internally and Externally SM1-Threaded Fiber Adapters



Click to Enlarge  
Each detector has an internal SM05 and external SM1 thread and comes with an attached SM1T1 Internal SM1 Adapter and SM1RR Retaining Ring.

##### Operating Circuit Diagram

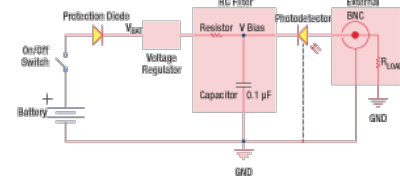

Click to Enlarge  
The detectors are reverse biased to produce a linear response with applied input light.

Thorlabs' Biased Photodetectors are available in eleven

models that cover the wavelength range from the UV to the mid-IR (150 nm to 2.6  $\mu\text{m}$ ). The slim housing allows the optical detector to slip into tight setups. Each model comes complete with a fast PIN photodiode and an internal bias battery packaged in a rugged aluminum housing. Our biased photodetectors are compatible with our benchtop photodiode amplifier and PMT transimpedance amplifier.

With a wide bandwidth DC-coupled output, these detectors are ideal for monitoring fast pulsed lasers as well as DC optical sources. The direct photodiode anode current is provided on a side panel BNC. This output is easily converted to a positive voltage using a terminating resistor. When looking at high-speed signals, Thorlabs recommends using a 50  $\Omega$  load resistor. For lower bandwidth applications, our variable terminator or fixed stub-style terminators quickly adjusts the measured voltage. The detectors below do not have amplifiers or built-in gain, which generally allows them to operate at higher speeds than our PDA series of amplified photodetectors; for applications that require gain or switchable filters, a PDA amplified photodetector may be more suitable.

All connections and controls are located away from the light path, which simplifies integration of our detectors in enclosed spaces. Every detector has internal SM05 (0.535"-40) threading and external SM1 (1.035"-40) threading. Each DET housing includes a detachable  $\text{\O}1$ " Optic Mount (SM1T1) that allows for  $\text{\O}1$ " optical components, such as optical filters and lenses, to be mounted along the optical axis. Each DET detector can also be mounted in a



Click to Enlarge  
The Red Battery  
Test Button on the  
DET10D2

cage system, lens tube system, or on a  $\varnothing 1/2"$  optical post. Except for some select detectors, each unit's housing features 8-32 tapped holes (M4 for /M models). The DET10A2, DET100A2, DET10N2, DET10D2, DET30B2, and DET50B2 feature a new housing with two universal taps that accept both 8-32 and M4. For more information about the location of these mounting points and mounting these units, please see the *Housing Features* and *Mounting Options* tabs.

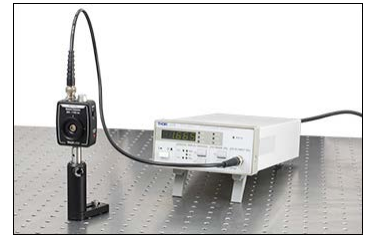

Click to Enlarge  
PDA200C Benchtop Photodiode Amplifier Connected to  
a DET10A2 Photodetector Using a BNC Cable

Each detector is reverse-biased by an A23 12 VDC battery incorporated into the housing. The housing also includes a red button (pictured to the left) which, when held down, applies the battery's voltage across the external load. For a high-Z load, this will output the battery's voltage over BNC, providing an easy way to determine if the battery should be replaced without removing it from the housing. An in-line current-limiting resistor prevents fast battery drainage if the battery is tested while connected to a 50  $\Omega$  load. Please note that due to slight physical variations of the positive terminal from manufacturer to manufacturer, Thorlabs only recommends using an Energizer<sup>®</sup> battery in our DET series of photodetectors. A battery was chosen for the reverse bias because it provides an extremely low noise source of power. If the finite lifetime of a battery is not acceptable, the battery can be replaced by a DET1B Power Supply Kit. Extra batteries and the DET1B are available for purchase below.

Please note that inhomogeneities at the edges of the active area of the detector can generate unwanted capacitance and resistance effects that distort the time-domain response of the photodiode output. Thorlabs therefore recommends that the incident light on the photodiode is well centered on the active area. The SM1 (1.035"-40) threading on the housing is ideally suited for mounting a  $\varnothing 1"$  focusing lens or pinhole in front of the detector element.

Thorlabs also offers high-speed free-space detectors and high-speed fiber-coupled detectors for wavelengths between 400 - 1700 nm.

[Hide Graphs](#)

GRAPHS

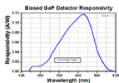

Click to Enlarge  
Click Here for  
Raw Data

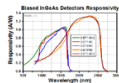

Click to Enlarge  
Click Here for  
Raw Data

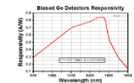

Click to Enlarge  
Click Here for  
Raw Data

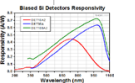

Click to Enlarge  
Click Here for  
Raw Data

[Hide Housing Features](#)

HOUSING FEATURES

**DET Series Housing Features**

Thorlabs' high-speed detectors feature a slim design. Each housing features internal SM05 (0.535"-40) threading and external SM1 (1.035"-40) threading. All detectors include an SM1T1 internally SM1-threaded adapter and an SM1RR retaining ring. Most SM1-threaded fiber adapters are compatible with these detectors.

Threaded holes on the housings of the detectors allow the units to be mounted in a horizontal or vertical orientation, which gives the user the option to route the power and BNC cables from above or alongside the beam path. Except for some select detectors, each detector has two 8-32 threaded holes, while its metric counterpart has two M4 threaded holes. The DET10A2, DET100A2, DET10N2, DET10D2, DET30B2, and DET50B2 have a new design that features two universally threaded holes compatible with both 8-32 and M4 threads (see the table below). As a convenience, this new design also has the back panel engraved with the responsivity curve of the photodiode. For more information on mounting these units, please see the *Mounting Options* tab.



Click to Enlarge  
Each detector has an internal SM05 and external SM1 thread and comes with an attached SM1T1 Internal SM1 Adapter and SM1RR Retaining Ring.



Click to Enlarge  
All detector housings have a red battery check button. The DET10D2 is shown here.

Detector Item #	Housing Drawing (Click Icon for Details)	Mounting Taps	SM Thread Compatibility	Dimensions	Output Connector
DET25K, DET36A, DET20C, DET05D, DET10C		Two 8-32 Taps (M4 for Metric Version)	Internal SM05 (0.535"-40) External SM1 (1.035"-40)	48.0 mm x 21.1 mm x 70.1 mm (1.89" x 0.83" x 2.76")	BNC
DET10A2, DET100A2, DET10N2, DET10D2,		Two Universal Taps for 8-32 and M4		49.8 mm x 22.5 mm x 70.9 mm (1.96" x 0.89" x 2.79")	



a. The internal SM05 (0.535"-40) threading is not accessible on the DET50B2.

[Hide Pin Diagrams](#)

## PIN DIAGRAMS

### Output Voltage Signal BNC Female

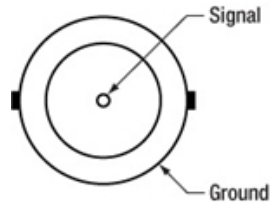

50  $\Omega$  Recommended Termination. For max output, please see detector drawings below.

[Hide Battery Lifetime](#)

## BATTERY LIFETIME

### Battery Lifetime

When using a battery-operated photodetector, it is important to understand the battery's lifetime and how this affects the operation of the detector. As a current output device, the output current of the photodetector is directly proportional to the amount of incident light on the detector. Most users will convert this current to a voltage by using a terminating load resistor. The resistance value is approximately equal to the circuit gain. For very high speed detectors, such as the DET08 series, it is very important to use a 50  $\Omega$  terminating resistor to match the impedance of standard coaxial cables to reduce cable reflections and improve overall signal performance and integrity. Most high-bandwidth scopes come equipped with this termination.

The battery usage lifetime directly correlates to the current used by the detector. Most battery manufacturers provide a battery lifetime in terms of mAh (milliamp hours). For example, if a battery is rated for 190 mA hrs, it will reliably operate for 190 hr at a current draw of 1.0 mA. This battery will be used in the following example on how to determine battery lifetime based on usage.

For this example we have a 780 nm light source with an average 1 mW power is applied to a detector. The responsivity of a biased photodetector based on the response curve at this wavelength is 0.5 A/W. The photocurrent can be calculated as:

$$\begin{aligned} I_{\text{current}} &= 0.5 \text{ A/W} \times 1 \text{ mW} \\ &= 0.5 \text{ mA} \end{aligned}$$

Given the battery has a rated lifetime of 190 mA hr, the battery will last:

$$\begin{aligned} T &= \frac{190 \text{ mA hr}}{0.5 \text{ mA}} \\ &= 380 \text{ hr} \end{aligned}$$

or 16 days of continuous use. By reducing the average incident power of the light to 10  $\mu\text{W}$ , the same battery would last for about 4 years when used continuously. When using the recommended 50  $\Omega$  terminating load, the 0.5 mA photocurrent will be converted into a voltage of:

$$\begin{aligned} V &= I \times R \\ &= 0.5 \text{ mA} \times 50 \Omega \\ &= 25 \text{ mV} \end{aligned}$$

If the incident power level is reduced to 40  $\mu\text{W}$ , the output voltage becomes 1 mV. For some measurement devices this signal level may be too low and a compromise between battery life and measurement accuracy will need to be made.

When using a battery-powered, biased photodetector, it is desirable to use as low a light intensity as is possible, keeping in mind the minimum voltage levels required. It is also important to remember that a battery will not immediately cease producing a current as it nears the end of its lifetime. Instead, the voltage of the battery will drop, and the electric potential being applied to the photodiode will decrease. This in turn will increase the response time of the detector and lower its bandwidth. As a result, it is important to make sure the battery has sufficient voltage (as given in the *Troubleshooting* chapter of the detector's manual) for the detector to operate within its specified parameters. The voltage can be checked with a multimeter.



Another suggestion to increase the battery lifetime is to remove, or power down the light source illuminating the sensor. Without the light source, the photodetector will continue to draw current proportional to the photodetector's dark current, but this current will be significantly smaller.

For applications where a DET series photodetector is continuously illuminated with a relatively high-power light source, or if having to change the battery is not acceptable, we offer the DET1B adapter and power supply (sold below). The drawback to this option is the noise in the line voltage will add to the noise in the output signal and could cause more measurement uncertainty.

[Hide Mounting Options](#)

**MOUNTING OPTIONS**

The DET series biased photodiode detector housing is compatible with our line of lens tubes, TR series Ø1/2" posts, and cage systems. Because of the flexibility, the best method for mounting the housing in a given optical setup is not always obvious. The pictures and text in this tab will discuss some of the common mounting solutions. As always, our technical support staff is available for individual consultation.

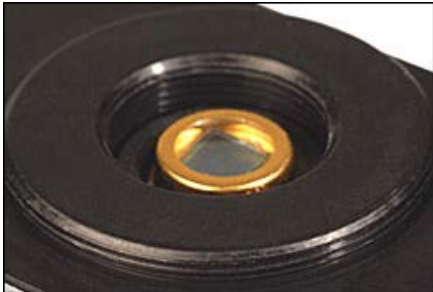
		
<p>Picture of a DET series biased photodiode detector as it will look when unpackaged.</p>	<p>Picture of a DET series biased photodiode detector with the included SM1T1 and its retaining ring removed from the front of the housing.</p>	<p>A close up picture of the front of a DET series biased photodiode detector with the SM1T1 removed. The external SM1 and internal SM05 threading on the detector housing can be seen in this image.</p>

**Lens Tube System**

Each DET housing includes a detachable Ø1" Optic Mount (SM1T1) that allows for Ø1" (Ø25.4 mm) optical components, such as optical filters and lenses, to be mounted along the axis perpendicular to the center of the photosensitive region. The maximum thickness of an optic that can be mounted in the SM1T1 is 0.1" (2.8 mm). For thicker Ø1" (Ø25.4 mm) optics or for any thickness of Ø0.5" (Ø12.7 mm) optics, remove the SM1T1 from the front of the detector and place (must be purchased separately) an SM1 or SM05 series lens tube, respectively, on the front of the detector.

The SM1 and SM05 threading on the DET biased photodiode detector housing make it compatible with our SM lens tube system and accessories. Two particularly useful accessories include the SM threaded irises and the SM compatible IR and visible alignment tools. Also available are fiber optic adapters for use with connectorized fibers; please see the *Accessories* tab above.

**Ø1/2" Post System**

The DET housing can be mounted vertically or horizontally on a Ø1/2" Post using the 8-32 (M4 on metric versions) threaded holes. Select DET housings feature universally threaded holes for both 8-32 and M4 threads.

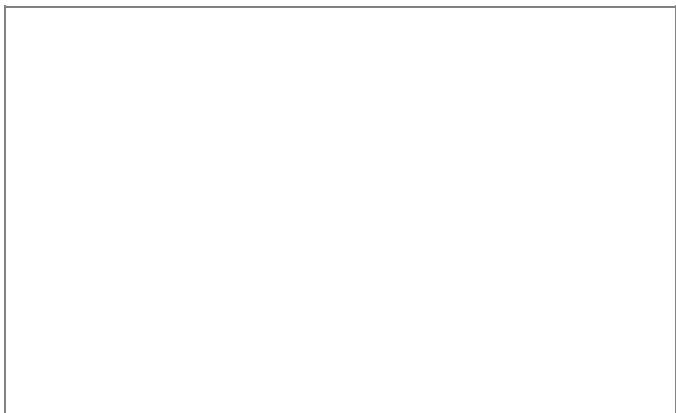
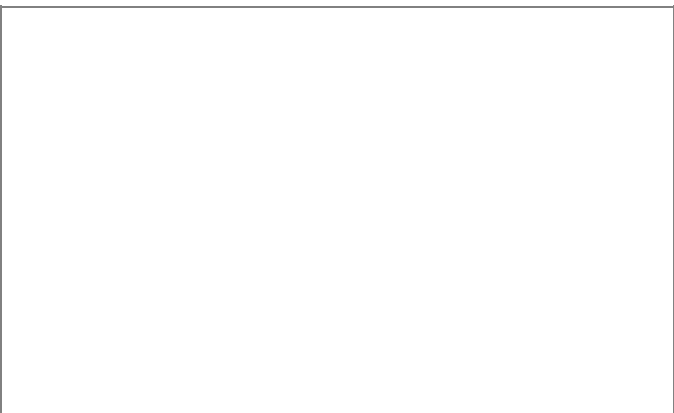
	
---	--



DET series detector mounted horizontally on a TR series post. Notice how the on/off switch is easily accessible from the top and the electrical connection comes in perpendicular to the beam path.



DET series detector mounted vertically on a TR series post. This image shows the VBIAS OUT button that can be pressed and held to check the battery's charge (this process is described in the manual).

### Cage System

The simplest method for attaching the DET biased photodiode detector housing to a cage plate is to remove the SM1T1 that is attached to the front of the DET when it is shipped. This will expose external SM1 threading that is deep enough to thread the detector directly to a CP02 30 mm cage plate. When the CP02 cage plate is tightened down onto the DET biased photodiode detector housing the cage plate will not necessarily be square with the detector. To fix this, back off the cage plate until it is square with the detector and then use the retaining ring included with the SM1T1 to lock the DET detector into the desired location. This method for attaching the DET biased photodiode detector housing to a cage plate does not allow for much freedom in determining the orientation of the biased photodiode detector; however, it has the benefit of not needing an adapter piece and it allows the photodiode to be as close as possible to the cage plate, which can be important in setups where the light is divergent. On a side note, Thorlabs sells the SM05PD and SM1PD series of photodiodes that can be threaded into a cage plate so that the diode is flush with the front surface of the cage plate; however, the photodiode is unbiased.

For more freedom in choosing the orientation of the DET biased photodiode detector housing when attaching it, a SM1T2 lens tube coupler can be purchased. In this configuration the SM1T1 is left on the detector and the SM1T2 is threaded into it. The exposed external SM1 threading is now deep enough to secure the biased photodiode detector to a CP02 cage plate in any orientation and lock it into place using one of the two locking rings on the ST1T2.

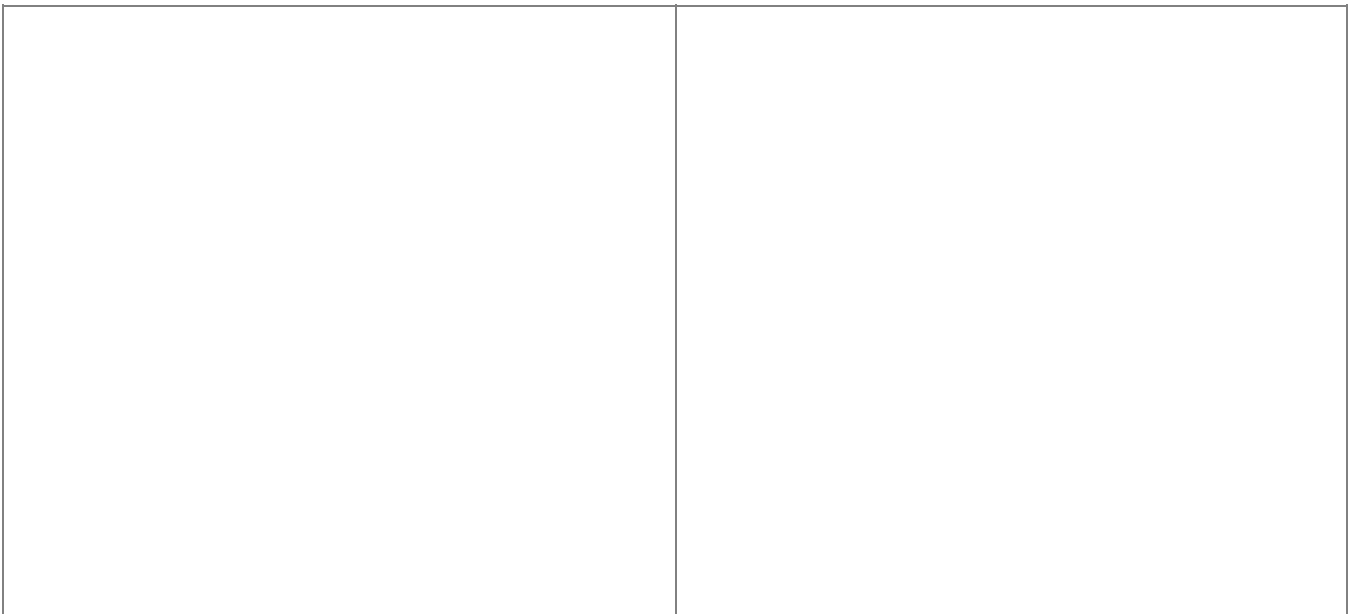



This picture shows a DET series detector attached to a CP02 cage plate after removing the SM1T1. The retaining ring from the SM1T1 was used to make the orientation of the detector square with the cage plate.



This picture shows a DET series detector attached to a CP02 cage plate using an SM1T2 adapter in addition to the SM1T1 that comes with the DET series detector.

Although not pictured here, the DET detector housing can be connected to a 16 mm cage system by purchasing a SM05T2. It can be used to connect the DET detector housing to a SP02 cage plate.

## Application

The image below shows a Michelson Interferometer built entirely from parts available from Thorlabs. This application demonstrates the ease with which an optical system can be constructed using our lens tube, TR series post, and cage systems.



The table contains a part list for the Michelson Interferometer with links to the pages that contain information about the individual parts.

Item #	Quantity	Description	Item #	Quantity	Description
KC1	1	Mirror Mount	SM1V05	1	Ø1" Adjustable Length Lens Tube

BB1-E03	2	Broadband Dielectric Laser Mirrors	SM1D12	1	SM1 Threaded Lens Tube Iris
ER4	8	Cage Rods, 4" Long	CP08FP	1	30 mm Cage Plate for FiberPorts
ER6	4	Cage Rods, 6" Long	SM1Z		Cage System Z-Axis Translation Mount
CCM1-BS014	1	Mounted Beamsplitting Cube	SM1L30	1	Ø1" Lens Tube, 3" in Length
DET36A	1	Biased Photodiode Detector	PAF-X-2-B	1	FiberPort
TR2	1	Ø1/2" Post, 2" in Length	BA2	1	Post Base
PH2	1	Ø1/2" Post Holder	P1-830A-FC-2	1	Single Mode Fiber Patch Cable

[Hide Photodiode Tutorial](#)

## PHOTODIODE TUTORIAL

### Photodiode Tutorial

#### Theory of Operation

A junction photodiode is an intrinsic device that behaves similarly to an ordinary signal diode, but it generates a photocurrent when light is absorbed in the depleted region of the junction semiconductor. A photodiode is a fast, highly linear device that exhibits high quantum efficiency based upon the application and may be used in a variety of different applications.

It is necessary to be able to correctly determine the level of the output current to expect and the responsivity based upon the incident light. Depicted in Figure 1 is a junction photodiode model with basic discrete components to help visualize the main characteristics and gain a better understanding of the operation of Thorlabs' photodiodes.

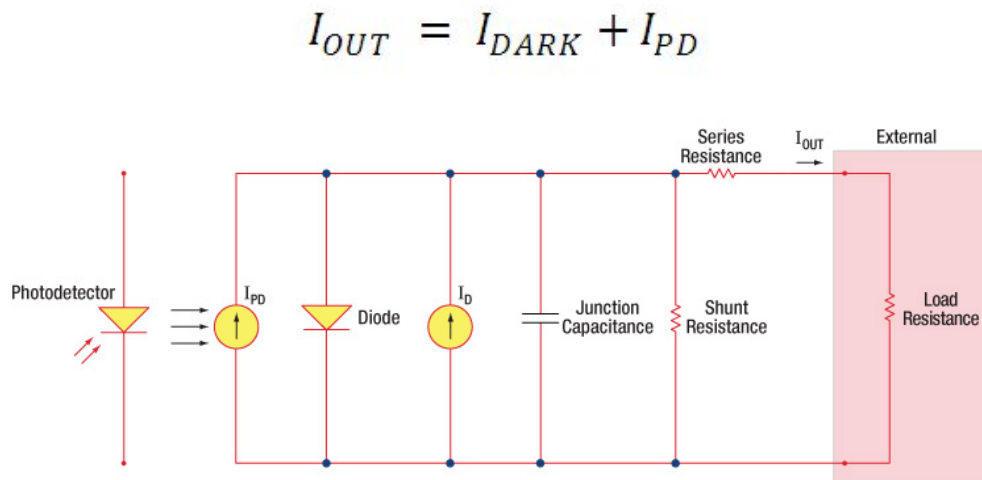

Figure 1: Photodiode Model

### Photodiode Terminology

#### Responsivity

The responsivity of a photodiode can be defined as a ratio of generated photocurrent ( $I_{PD}$ ) to the incident light power ( $P$ ) at a given wavelength:

$$R(\lambda) = \frac{I_{PD}}{P}$$

#### Modes of Operation (Photoconductive vs. Photovoltaic)

A photodiode can be operated in one of two modes: photoconductive (reverse bias) or photovoltaic (zero-bias). Mode selection depends upon the application's speed requirements and the amount of tolerable dark current (leakage current).

#### Photoconductive

In photoconductive mode, an external reverse bias is applied, which is the basis for our DET series detectors. The current measured through the circuit indicates illumination of the device; the measured output current is linearly proportional to the input optical power. Applying a reverse bias increases the width of the depletion junction producing an increased responsivity with a decrease in junction capacitance and produces a very linear response. Operating under these conditions does tend to produce a larger dark current, but this can be limited based upon the photodiode material. (Note: Our DET detectors are reverse biased and cannot be operated under a forward bias.)

### Photovoltaic

In photovoltaic mode the photodiode is zero biased. The flow of current out of the device is restricted and a voltage builds up. This mode of operation exploits the photovoltaic effect, which is the basis for solar cells. The amount of dark current is kept at a minimum when operating in photovoltaic mode.

### Dark Current

Dark current is leakage current that flows when a bias voltage is applied to a photodiode. When operating in a photoconductive mode, there tends to be a higher dark current that varies directly with temperature. Dark current approximately doubles for every 10 °C increase in temperature, and shunt resistance tends to double for every 6 °C rise. Of course, applying a higher bias will decrease the junction capacitance but will increase the amount of dark current present.

The dark current present is also affected by the photodiode material and the size of the active area. Silicon devices generally produce low dark current compared to germanium devices which have high dark currents. The table below lists several photodiode materials and their relative dark currents, speeds, sensitivity, and costs.

Material	Dark Current	Speed	Spectral Range	Cost
Silicon (Si)	Low	High Speed	Visible to NIR	Low
Germanium (Ge)	High	Low Speed	NIR	Low
Gallium Phosphide (GaP)	Low	High Speed	UV to Visible	Moderate
Indium Gallium Arsenide (InGaAs)	Low	High Speed	NIR	Moderate
Indium Arsenide Antimonide (InAsSb)	High	Low Speed	NIR to MIR	High
Extended Range Indium Gallium Arsenide (InGaAs)	High	High Speed	NIR	High
Mercury Cadmium Telluride (MCT, HgCdTe)	High	Low Speed	NIR to MIR	High

### Junction Capacitance

Junction capacitance ( $C_j$ ) is an important property of a photodiode as this can have a profound impact on the photodiode's bandwidth and response. It should be noted that larger diode areas encompass a greater junction volume with increased charge capacity. In a reverse bias application, the depletion width of the junction is increased, thus effectively reducing the junction capacitance and increasing the response speed.

### Bandwidth and Response

A load resistor will react with the photodetector junction capacitance to limit the bandwidth. For best frequency response, a 50 Ω terminator should be used in conjunction with a 50 Ω coaxial cable. The bandwidth ( $f_{BW}$ ) and the rise time response ( $t_r$ ) can be approximated using the junction capacitance ( $C_j$ ) and the load resistance ( $R_{LOAD}$ ):

$$f_{BW} = 1 / (2 * \pi * R_{LOAD} * C_j)$$
$$t_r = 0.35 / f_{BW}$$

### Noise Equivalent Power

The noise equivalent power (NEP) is the generated RMS signal voltage generated when the signal to noise ratio is equal to one. This is useful, as the NEP determines the ability of the detector to detect low level light. In general, the NEP increases with the active area of the detector and is given by the following equation:

$$NEP = \frac{\text{Incident Energy} * \text{Area}}{\frac{S}{N} * \sqrt{\Delta f}}$$

Here, S/N is the Signal to Noise Ratio, Δf is the Noise Bandwidth, and Incident Energy has units of W/cm<sup>2</sup>. For more information on NEP, please see Thorlabs' Noise Equivalent Power White Paper.

### Terminating Resistance

A load resistance is used to convert the generated photocurrent into a voltage ( $V_{OUT}$ ) for viewing on an oscilloscope:

$$V_{OUT} = I_{OUT} * R_{LOAD}$$



Depending on the type of the photodiode, load resistance can affect the response speed. For maximum bandwidth, we recommend using a 50  $\Omega$  coaxial cable with a 50  $\Omega$  terminating resistor at the opposite end of the cable. This will minimize ringing by matching the cable with its characteristic impedance. If bandwidth is not important, you may increase the amount of voltage for a given light level by increasing  $R_{LOAD}$ . In an unmatched termination, the length of the coaxial cable can have a profound impact on the response, so it is recommended to keep the cable as short as possible.

### Shunt Resistance

Shunt resistance represents the resistance of the zero-biased photodiode junction. An ideal photodiode will have an infinite shunt resistance, but actual values may range from the order of ten  $\Omega$  to thousands of  $M\Omega$  and is dependent on the photodiode material. For example, an InGaAs detector has a shunt resistance on the order of 10  $M\Omega$  while a Ge detector is in the  $k\Omega$  range. This can significantly impact the noise current on the photodiode. For most applications, however, the high resistance produces little effect and can be ignored.

### Series Resistance

Series resistance is the resistance of the semiconductor material, and this low resistance can generally be ignored. The series resistance arises from the contacts and the wire bonds of the photodiode and is used to mainly determine the linearity of the photodiode under zero bias conditions.

## Common Operating Circuits

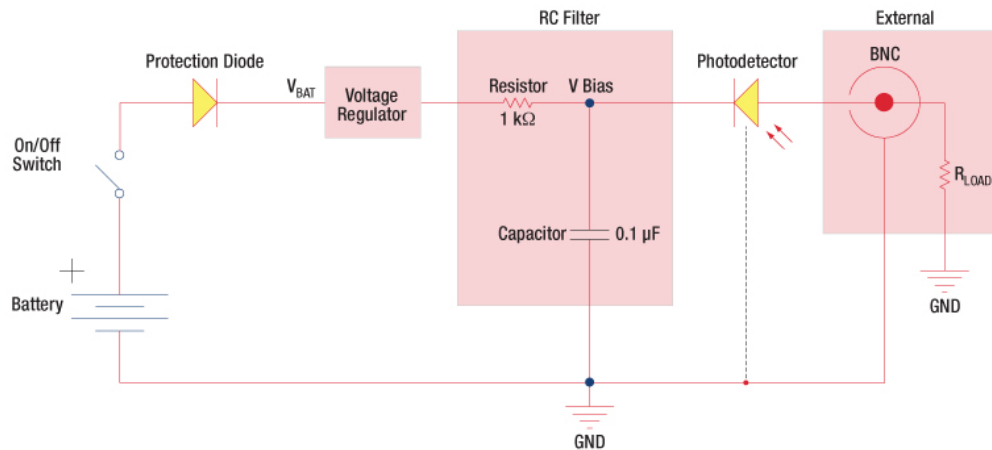

Figure 2: Reverse-Biased Circuit (DET Series Detectors)

The DET series detectors are modeled with the circuit depicted above. The detector is reverse biased to produce a linear response to the applied input light. The amount of photocurrent generated is based upon the incident light and wavelength and can be viewed on an oscilloscope by attaching a load resistance on the output. The function of the RC filter is to filter any high-frequency noise from the input supply that may contribute to a noisy output.

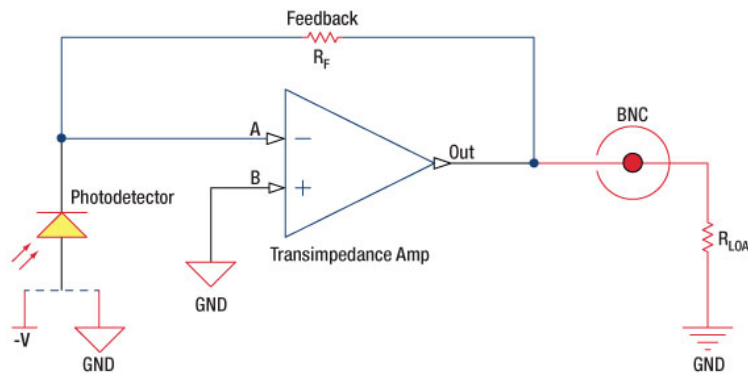

Figure 3: Amplified Detector Circuit

One can also use a photodiode with an amplifier for the purpose of achieving high gain. The user can choose whether to operate in Photovoltaic or Photoconductive modes. There are a few benefits of choosing this active circuit:

- Photovoltaic mode: The circuit is held at zero volts across the photodiode, since point A is held at the same potential as point B by the operational amplifier. This eliminates the possibility of dark current.
- Photoconductive mode: The photodiode is reverse biased, thus improving the bandwidth while lowering the junction capacitance. The gain of the detector is dependent on the feedback element ( $R_f$ ). The bandwidth of the detector can be calculated using the following:

$$f(-3dB) = \sqrt{\frac{GBP}{4\pi * R_f * C_D}}$$

where GBP is the amplifier gain bandwidth product and  $C_D$  is the sum of the junction capacitance and amplifier capacitance.

### Effects of Chopping Frequency

The photoconductor signal will remain constant up to the time constant response limit. Many detectors, including PbS, PbSe, HgCdTe (MCT), and InAsSb, have a typical 1/f noise spectrum (i.e., the noise decreases as chopping frequency increases), which has a profound impact on the time constant at lower frequencies.

The detector will exhibit lower responsivity at lower chopping frequencies. Frequency response and detectivity are maximized for

$$f_c = \frac{1}{2\pi\tau_r}$$

[Hide Lab Facts](#)

## LAB FACTS

### Dark Current as a Function of Temperature or Reverse-Bias Voltage

Measurements of dark current as a function of temperature and dark current as a function of reverse-bias voltage were acquired for several packaged detectors. As is described in the following section, dark current is a relatively small electrical current that flows in p-n junction photodetectors when no light is incident on the detector. For certain applications, it may be necessary to account for the change in dark current as temperature fluctuates and/or as the reverse-bias voltage changes. As a consequence of a battery's supplied voltage decreasing as it drains, the relationship between the reverse-bias voltage and the dark current level may be of particular interest if a battery is used to reverse-bias voltage the photodiode.

One set of measurements were taken for silicon (Si), germanium (Ge), and indium gallium arsenide (InGaAs) reverse-biased photodiodes over temperatures from 10 °C to 50 °C, and another set of measurements were taken for the same detectors while they were held at 24 °C and the reverse-bias voltage varied from 0 to 10 V. Please click the "More [+]" labels in the following expandable tables to read about the experiments and our measurements.

### Current-Voltage Characteristics of p-n Junction Photodiodes

The characteristic current-voltage relationship of p-n junction photodiodes includes a forward-biased and a reverse-biased voltage regime. Operation of p-n junction photodiodes occurs in the reverse-biased voltage regime, in which a potential difference is applied across the diode to resist the flow of current. A convenient feature of some packaged photodiodes is that a battery inserted into the package can supply the reverse-bias voltage. Ideally, if no light is incident on a reverse-biased photodiode, no current flows.

Under real-world conditions, random processes in the semiconductor material of the photodiode always generate current carriers (electrons and holes) that produce current. These current generation processes are not driven by the photogeneration of electrons and holes. Instead, they are largely driven by the thermal energy contained in the semiconductor material.[1] This dark current is generally small, but it is present when the photodiode is reverse biased and not illuminated. Dark current magnitudes vary for photodiodes of different material compositions; the efficiencies of the thermal generation processes depend on the type and crystal quality of the semiconductor used in the detector's sensing head. The magnitude of the dark current can be expected to increase as the temperature of the photodiode increases and as the reverse-bias voltage applied to the photodiode increases.

It is important to note that if the reverse bias voltage is increased beyond a certain threshold, the photodiode will suffer reverse breakdown, in which the magnitude of the current increases exponentially and permanent damage to the diode is likely. For this reason, many of the Thorlabs DET packages include a voltage regulator to prevent the bias voltage from reaching breakdown.

When a photodiode is illuminated, the current generated by the incident light adds to the dark current. The carriers in the photocurrent are generated by the energy contained in the photons of the incident light. Above a certain illumination threshold intensity, the magnitude of the photocurrent exceeds the magnitude of the dark current. When the photocurrent is larger than the dark current, the magnitude of the photocurrent can be calculated by measuring the total current and then subtracting the contribution of the dark current. When the photocurrent is smaller than the noise on the dark current, the photocurrent is undetectable. Because of this, it is desirable to minimize the levels of dark current in photodiodes.

[1] J. Liu, Photonic Devices. Cambridge University Press, Cambridge, UK, 2005

## Dark Current as a Function of Temperature

## Dark Current as a Function of Reverse-Bias Voltage

### About Our Lab Facts

Our application engineers live the experience of our customers by conducting experiments in Alex's personal lab. Here, they gain a greater understanding of our products' performance across a range of application spaces. Their results can be found throughout our website on associated product pages in *Lab Facts* tabs. Experiments are used to compare performance with theory and look at the benefits and drawbacks of using similar products in unique setups, in an attempt to understand the intricacies and practical limitations of our products. In all cases, the theory, procedure, and results are provided to assist with your buying decisions.

[Hide Cross Reference](#)

## CROSS REFERENCE

The following table lists Thorlabs' selection of photodiodes and photoconductive detectors. Item numbers in the same row contain the same detector element.



Photodetector Cross Reference						
Wavelength	Material	Unmounted Photodiode	Unmounted Photoconductor	Mounted Photodiode	Biased Detector	Amplified Detector
150 - 550 nm	GaP	FGAP71	-	SM05PD7A	DET25K(/M)	PDA25K2
200 - 1100 nm	Si	FDS010	-	SM05PD2A SM05PD2B	DET10A2	PDA10A2
	Si	-	-	SM1PD2A	-	-
320 - 1000 nm	Si	-	-	-	-	PDA8A(/M)
320 - 1100 nm	Si	FD11A	-	SM05PD3A	-	PDF10A(/M)
	Si	-	-	-	DET100A2	PDA100A2
340 - 1100 nm	Si	FDS10X10	-	-	-	-
350 - 1100 nm	Si	FDS100 FDS100-CAL <sup>a</sup>	-	SM05PD1A SM05PD1B	DET36A(/M)	PDA36A2
	Si	FDS1010 FDS1010-CAL <sup>a</sup>	-	SM1PD1A SM1PD1B	-	-
400 - 1000 nm	Si	-	-	-	-	PDA015A(/M) FPD310-FS-VIS FPD310-FC-VIS FPD510-FC-VIS FPD610-FC-VIS FPD610-FS-VIS
400 - 1100 nm	Si	FDS015 <sup>b</sup>	-	-	-	-
	Si	FDS025 <sup>b</sup> FDS02 <sup>c</sup>	-	-	DET02AFC(/M) DET025AFC(/M) DET025A(/M) DET025AL(/M)	-
400 - 1700 nm	Si & InGaAs	DSD2	-	-	-	-
500 - 1700 nm	InGaAs	-	-	-	DET10N2	-
750 - 1650 nm	InGaAs	-	-	-	-	PDA8GS
800 - 1700 nm	InGaAs	FGA015	-	-	-	PDA015C(/M)
	InGaAs	FGA21 FGA21-CAL <sup>a</sup>	-	SM05PD5A	DET20C(/M)	PDA20C(/M) PDA20CS2
	InGaAs	FGA01 <sup>b</sup> FGA01FC <sup>c</sup>	-	-	DET01CFC(/M)	-
	InGaAs	FDGA05 <sup>b</sup>	-	-	-	PDA05CF2
	InGaAs	-	-	-	DET08CFC(/M) DET08C(/M) DET08CL(/M)	PDF10C(/M)

800 - 1800 nm	Ge	FDG03 FDG03-CAL <sup>a</sup>	-	SM05PD6A	DET30B2	PDA30B2
	Ge	FDG50	-	-	DET50B2	PDA50B2
	Ge	FDG05	-	-	-	-
800 - 2600 nm	InGaAs	-	-	-	DET05D(M)	PDA10D(-EC)
850 - 1650 nm	InGaAs	-	-	-	-	FPD510-F
900 - 1700 nm	InGaAs	FGA10	-	SM05PD4A	DET10C(M)	PDA10CS(-EC)
900 - 2600 nm	InGaAs	FD05D	-	-	-	-
		FD10D	-	-	-	-
		-	-	-	DET10D2	-
950 - 1650 nm	InGaAs	-	-	-	-	FPD310-FC-NIR FPD310-FS-NIR FPD510-FC-NIR FPD610-FC-NIR FPD610-FS-NIR
1.0 - 2.9 μm	PbS	-	FDPS3X3	-	-	PDA30G(-EC)
1.0 - 5.8 μm	InAsSb	-	-	-	-	PDA10PT(-EC)
1.5 - 4.8 μm	PbSe	-	FDPSE2X2	-	-	PDA20H(-EC)
2.0 - 5.4 μm	HgCdTe (MCT)	-	-	-	-	PDA10JT(-EC)
2.0 - 8.0 μm	HgCdTe (MCT)	VML8T0 VML8T4 <sup>d</sup>	-	-	-	PDAVJ8
2.0 - 10.6 μm	HgCdTe (MCT)	VML10T0 VML10T4 <sup>d</sup>	-	-	-	PDAVJ10
2.7 - 5.0 μm	HgCdTe (MCT)	VL5T0	-	-	-	-

- a. Calibrated Unmounted Photodiode
- b. Unmounted TO-46 Can Photodiode
- c. Unmounted TO-46 Can Photodiode with FC/PC Bulkhead
- d. Photovoltaic Detector with Thermoelectric Cooler

[Hide Biased GaP Detector: 150 - 550 nm](#)

### Biased GaP Detector: 150 - 550 nm

Item # <sup>a</sup>	Housing Features	Active Area	Wavelength Range	Rise / Fall Time <sup>b,c,d</sup>	Bandwidth <sup>e</sup>	Noise-Equivalent Power (NEP) (Typ.)	Dark Current <sup>f</sup>	Junction Capacitance	Bias Voltage	Responsivity Data (Click Here for Raw Data)
DET25K		4.8 mm <sup>2</sup> (2.2 x 2.2 mm)	150 - 550 nm	55 ns / 55 ns (Typ.)	6.4 MHz	1.3 x 10 <sup>-14</sup> W/Hz <sup>1/2</sup>	40 pA (Max)	500 pF (Typ.)	5.0 V	

- a. Click on the link to view a photo of each item.
- b. Measured with specified bias voltage of 5 V.
- c. Low battery voltage will result in slower rise times and decreased bandwidth.
- d. For a 50Ω Load
- e. Calculated value; based on the typical rise time and a 50 Ω load.
- f. Measured with a 1 MΩ Load

Part Number	Description	Price	Availability
DET25K/M	GaP Detector, 150 - 550 nm, 55 ns Rise Time, 4.8 mm <sup>2</sup> , M4 Taps	\$262.14	Today
DET25K	GaP Detector, 150 - 550 nm, 55 ns Rise Time, 4.8 mm <sup>2</sup> , 8-32 Taps	\$262.14	Today

[Hide Biased Si Detectors: 200 - 1100 nm](#)

### Biased Si Detectors: 200 - 1100 nm

Housing	Active	Wavelength	Rise	Noise-Equivalent	Dark	Junction	Bias	Responsivity Data <sup>f</sup> (Click Here for
---------	--------	------------	------	------------------	------	----------	------	--







Item # <sup>a</sup>	Features	Area	Range	Time <sup>b,c,d</sup>	Bandwidth	Power (NEP) (Typ.)	Current <sup>e</sup>	Capacitance	Voltage	Raw Data
DET10A2		0.8 mm <sup>2</sup> (Ø1.0 mm) <sup>g</sup>	200 - 1100 nm <sup>h</sup>	1 ns (Typ.)	350 MHz <sup>i</sup>	5.0 x 10 <sup>-14</sup> W/Hz <sup>1/2</sup>	0.3 nA (Typ.) 2.5 nA (Max)	6 pF (Typ.)	10 V	
DET36A		13 mm <sup>2</sup> (3.6 x 3.6 mm)	350 - 1100 nm	14 ns <sup>j</sup> (Typ.)	25 MHz <sup>k</sup>	1.6 x 10 <sup>-14</sup> W/Hz <sup>1/2</sup>	0.35 nA (Typ.) 6.0 nA (Max)	40 pF (Typ.)	10 V	
DET100A2		75.4 mm <sup>2</sup> (Ø9.8 mm)	320 - 1100 nm	35 ns <sup>j</sup> (Typ.)	8 MHz <sup>k</sup>	2.4 x 10 <sup>-14</sup> W/Hz <sup>1/2</sup>	0.9 nA (Typ.) 10 nA (Max)	150 pF (Typ.)	10 V	

- Click on the link to view a photo of each item.
- Measured with a specified bias voltage of 10.0 V.
- Low battery voltage will result in slower rise times and decreased bandwidth.
- For a 50Ω Load
- Measured with a 1 MΩ Load
- If a flattened wavelength-dependent responsivity curve is desired, please see our response-flattening filters for Si photodiodes and detectors.
- The detector active area surface is flush with the front the housing.
- When long-term UV light is applied, the product specifications may degrade. For example, the product's UV response may decrease and the dark current may increase. The degree to which the specifications may degrade is based upon factors such as the irradiation level, intensity, and usage time.
- Calculated based on the typical rise time and with a 50 Ω load.
- Specified at 632 nm. The photodiode will be slower at NIR wavelengths.
- Calculated value based on the typical rise time at 632 nm and with a 50 Ω load. Bandwidth will decrease at NIR wavelengths.

Part Number	Description	Price	Availability
DET36A/M	Si Detector, 350 - 1100 nm, 14 ns Rise Time, 13 mm <sup>2</sup> , M4 Taps	\$123.42	Today
DET10A2	NEW! Si Detector, 200 - 1100 nm, 1 ns Rise Time, 0.8 mm <sup>2</sup> , Universal 8-32 / M4 Taps	\$159.12	Today
DET100A2	NEW! Si Detector, 320 - 1100 nm, 35 ns Rise Time, 75.4 mm <sup>2</sup> , Universal 8-32 / M4 Taps	\$164.22	Today
DET36A	Si Detector, 350 - 1100 nm, 14 ns Rise Time, 13 mm <sup>2</sup> , 8-32 Taps	\$123.42	Today

[Hide Biased InGaAs Detectors: 500 - 2600 nm](#)

### Biased InGaAs Detectors: 500 - 2600 nm

Item # <sup>a</sup>	Housing Features	Active Area	Wavelength Range	Rise Time <sup>b,c</sup>	Bandwidth <sup>d</sup>	Noise-Equivalent Power (NEP) (Typ.)	Dark Current <sup>e</sup>	Junction Capacitance	Bias Voltage	Responsivity Data (Click Here for Raw Data)
DET10N2		0.8 mm <sup>2</sup> (Ø1.0 mm) <sup>f</sup>	500 - 1700 nm	5 ns <sup>g</sup> (Typ.)	70 MHz	2.0 x 10 <sup>-14</sup> W/Hz <sup>1/2</sup>	1.5 nA (Typ.) 10 nA (Max)	50 pF (Typ.)	5.0 V	
DET20C		3.14 mm <sup>2</sup> (Ø2.0 mm)	800 - 1700 nm	25 ns <sup>h</sup> (Typ.)	14 MHz	1.3 x 10 <sup>-13</sup> W/Hz <sup>1/2</sup>	55 nA (Typ.) 200 nA (Max)	100 pF (Typ.)	1.8 V	
DET05D		0.2 mm <sup>2</sup> (Ø0.5 mm)	800 - 2600 nm	17 ns <sup>h</sup> (Typ.)	20.6 MHz	1.0 x 10 <sup>-12</sup> W/Hz <sup>1/2</sup>	2 μA (Typ.) 20 μA (Max)	140 pF (Typ.)	1.8 V	
DET10C		0.8 mm <sup>2</sup> (Ø1.0 mm)	900 - 1700 nm	10 ns <sup>g</sup> (Typ.)	35 MHz	2.5 x 10 <sup>-14</sup> W/Hz <sup>1/2</sup>	1 nA (Typ.) 25 nA (Max)	80 pF (Typ.)	5.0 V	
DET10D2		0.8 mm <sup>2</sup> (Ø1.0 mm) <sup>f</sup>	900 - 2600 nm	25 ns <sup>h</sup> (Typ.)	14 MHz	1.5 x 10 <sup>-12</sup> W/Hz <sup>1/2</sup>	5 μA (Typ.) 40 μA (Max)	500 pF (Typ.)	1.8 V	



- Click on the link to view a photo of each item.
- Low battery voltage will result in slower rise times and decreased bandwidth.
- For a 50 Ω Load
- Calculated value; based on the typical rise time and a 50 Ω load.
- Measured with a 1MΩ Load

- f. The detector active area surface is flush with the front the housing.
- g. Measured with a specified bias voltage of 5.0 V.
- h. Measured with a specified bias voltage of 1.8 V.

Part Number	Description	Price	Availability
DET20C/M	InGaAs Detector, 800 - 1700 nm, 25 ns Rise Time, 3.14 mm <sup>2</sup> , M4 Taps	\$414.12	Today
DET05D/M	InGaAs Detector, 800 - 2600 nm, 17 ns Rise Time, 0.2 mm <sup>2</sup> , M4 Taps	\$375.36	Today
DET10C/M	InGaAs Detector, 900 - 1700 nm, 10 ns Rise Time, 0.8 mm <sup>2</sup> , M4 Taps	\$302.94	Today
DET10N2	NEW! InGaAs Detector, 500 - 1700 nm, 5 ns Rise Time, 0.8 mm <sup>2</sup> , Universal 8-32 / M4 Taps	\$513.06	Today
DET10D2	NEW! InGaAs Detector, 900 - 2600 nm, 25 ns Rise Time, 0.8 mm <sup>2</sup> , Universal 8-32 / M4 Taps	\$439.62	Today
DET20C	InGaAs Detector, 800 - 1700 nm, 25 ns Rise Time, 3.14 mm <sup>2</sup> , 8-32 Taps	\$414.12	Today
DET05D	InGaAs Detector, 800 - 2600 nm, 17 ns Rise Time, 0.2 mm <sup>2</sup> , 8-32 Taps	\$375.36	Today
DET10C	InGaAs Detector, 900 - 1700 nm, 10 ns Rise Time, 0.8 mm <sup>2</sup> , 8-32 Taps	\$302.94	Today

[Hide Biased Ge Detectors: 800 - 1800 nm](#)

### Biased Ge Detectors: 800 - 1800 nm

Item # <sup>a</sup>	Housing Features	Active Area	Wavelength Range	Rise Time <sup>b,c</sup>	Bandwidth <sup>d</sup>	Noise-Equivalent Power (NEP) (Typ.)	Dark Current <sup>e</sup>	Junction Capacitance	Bias Voltage	Responsivity Data (Click Here for Raw Data)
DET50B2		19.6 mm <sup>2</sup> (Ø5.0 mm) <sup>f</sup>	800 - 1800 nm	455 ns <sup>g</sup> (Typ.)	770 kHz	4.0 x 10 <sup>-12</sup> W/Hz <sup>1/2</sup>	40 µA (Typ.) 80 µA (Max)	4000 pF (Max)	5.0 V	
DET30B2		7.1 mm <sup>2</sup> (Ø3.0 mm) <sup>f</sup>	800 - 1800 nm	650 ns <sup>h</sup> (Typ.)	540 kHz	2.6 x 10 <sup>-12</sup> W/Hz <sup>1/2</sup>	4.0 µA (Max)	6 nF (Max)	1.8 V	

- a. Click on the link to view a photo of each item.
- b. For a 50Ω Load
- c. Low battery voltage will result in slower rise times and decreased bandwidth.
- d. Calculated value; based on the typical rise time and a 50Ω load.
- e. Measured with a 1 MΩ Load
- f. The detector active area surface is flush with the front the housing.
- g. Measured with a specified bias voltage of 5.0 V.
- h. Measured with a specified bias voltage of 1.8 V.

Part Number	Description	Price	Availability
DET50B2	NEW! Ge Detector, 800 - 1800 nm, 455 ns Rise Time, 19.6 mm <sup>2</sup> , Universal 8-32 / M4 Taps	\$426.36	Today
DET30B2	NEW! Ge Detector, 800 - 1800 nm, 650 ns Rise Time, 7.1 mm <sup>2</sup> , Universal 8-32 / M4 Taps	\$310.08	Today

[Hide Replacement Batteries for Photodetectors](#)

### Replacement Batteries for Photodetectors

- ▶ **A23:** For Currently Shipping DET Photodetectors
- ▶ **SBP12:** For Discontinued SV2-FC and SIR5-FC Fiber-Coupled Photodetectors
- ▶ **T505:** For Discontinued DET1-SI and DET2-SI Detectors

#### A23 and T505 Alkaline Batteries

The A23 and T505 are replacement alkaline batteries for Thorlabs' currently shipping and discontinued DET photodetectors. For cases where the finite lifetime of a battery is not acceptable, we also offer an AC power adapter; please see below for more information. Information on expected battery lifetime is in the *Battery Lifetime* tab above.

#### SBP12 Battery Pack

The SBP12 is a 12 V replacement alkaline battery pack for our SV2-FC and SIR5-FC fiber-coupled photodetectors. It completely replaces the 20 V battery that was originally used (Item # SBP20), which we can no longer offer due to shipping regulations. Our testing shows that a 12 V bias provides performance similar to a 20 V bias, and the performance is within the detectors' stated specifications.



Click to Enlarge  
Exploded View of

As shown by the photo to the right, the SBP12 consists of an A23 battery in a newly designed housing. You may already own this housing if you purchased your SV2-FC or SIR5-FC in or after October 2013, or if you have already purchased an SBP12. If you do own this housing, then it is necessary to purchase only the A23 battery.

SBP12 Battery Pack

Customers who own an SV2-FC or SIR5-FC detector purchased before October 2013 will need to bend two pins to ensure that the SBP12 battery pack makes electrical contact. The procedure is illustrated in the spec sheet of the battery, which can be downloaded here.

Part Number	Description	Price	Availability
A23	Replacement 12 V Alkaline Battery for DET Series (Except DET1-SI and DET2-SI)	\$5.03	Today
SBP12	Replacement 12 V Alkaline Battery Pack for SV2-FC or SIR5-FC	\$85.94	Today
T505	Replacement 22.5 V Alkaline Battery for DET1-SI and DET2-SI	\$17.14	Today

[Hide DET Power Adapter](#)

### DET Power Adapter

- ▶ **DET1A:** Power Adapter for DET Series Detectors
- ▶ **LDS9:** AC Power Supply
- ▶ **DET1B:** DET1A and LDS9 Bundle



DET1B Power Adapter Installation

The DET1A is a power adapter for our DET series detectors. The DET1A features a 2.5 mm mono jack and will directly replace the A23 battery, cap, and spring to allow the detector to run directly from our LDS9 power supply (sold separately).

The LDS9 is a 9 V regulated power supply with a ripple voltage of less than 10 mV RMS. Its features include a current limit for short circuit and overload protection, an on/off switch with an LED indicator, and a switchable AC input voltage (115 or 230 VAC).

Click to Enlarge  
Shown is the DET1B adapter bundle being used to replace a DET50B2 battery. The DET1B includes the DET1A power adapter and the LDS9 power supply.

The DET1B power supply bundle includes both the DET1A and LDS9. It can be used to replace the battery in our DET series detectors. To use the DET1B, simply replace the battery cap and battery with the included DET1A adapter, and then insert the 2.5 mm mono plug from the LDS9 power supply into the adapter. This procedure is depicted in the animation to the right.

Please also note that the LDS9 power supply offers a lower bias voltage than the 12 V provided by the standard A23 battery. To minimize noise, our photodetectors contain voltage regulators that expect a higher input voltage than the bias that is eventually applied to the detector. For best performance, we therefore recommend this power supply only when it can supply a higher bias than the detector requires. Using a lower voltage will reduce the detector's bandwidth and rise time.

Part Number	Description	Price	Availability
DET1B-EC	DET Power Adapter & Power Supply Bundle, 230 VAC	\$130.56	Today
LDS9-EC	9 VDC Regulated Power Supply, 2.5 mm Phono Plug, 230 VAC	\$85.94	Lead Time
DET1A	Customer Inspired! DET Power Adapter	\$42.84	3-5 Days
DET1B	DET Power Adapter & Power Supply Bundle, 120 VAC	\$125.46	Today
LDS9	9 VDC Regulated Power Supply, 2.5 mm Phono Plug, 120 VAC	\$85.94	Today

[Hide Internally SM1-Threaded Fiber Adapters](#)

### Internally SM1-Threaded Fiber Adapters

These internally SM1-threaded (1.035"-40) adapters mate connectorized fiber to any of our externally SM1-threaded components, including our photodiode power sensors, our thermal power sensors, and our photodetectors. These adapters are compatible with the housing of the photodetectors on this page.

Item #	S120-SMA	S120-ST	S120-SC	S120-LC
Click Image to Enlarge				
Fiber Connector Type <sup>a</sup>	SMA	ST	SC	LC
Thread	Internal SM1 (1.035"-40)			

a. Other Connector Types Available upon Request



Part Number	Description	Price	Availability
S120-SMA	SMA Fiber Adapter Cap with Internal SM1 (1.035"-40) Thread	\$39.78	Today
S120-ST	ST/PC Fiber Adapter Cap with Internal SM1 (1.035"-40) Thread	\$39.78	Today
S120-SC	SC/PC Fiber Adapter Cap with Internal SM1 (1.035"-40) Thread	\$49.98	Today
S120-LC	LC/PC Fiber Adapter Cap with Internal SM1 (1.035"-40) Thread	\$49.98	Today

[Hide Externally SM1-Threaded Fiber Adapters](#)

### Externally SM1-Threaded Fiber Adapters

- ▶ Externally SM1-Threaded (1.035"-40) Disks with FC/PC, FC/APC, SMA, or ST/PC Receptacle
- ▶ Light-Tight When Used with SM1 Lens Tubes
- ▶ Compatible with Many of Our 30 mm Cage Plates and Photodetectors

Each disk has four dimples, two in the front surface and two in the back surface, that allow it to be tightened from either side with the SPW909 or SPW801 spanner wrench. The dimples do not go all the way through the disk so that the adapters can be used in light-tight applications when paired with SM1 lens tubes. Once the adapter is at the desired position, use an SM1RR retaining ring to secure it in place.

Item #	SM1FC	SM1FCA <sup>a</sup>	SM1SMA	SM1ST
Adapter Image (Click the Image to Enlarge)				
Connector Type	FC/PC	FC/APC	SMA	ST/PC
Threading	External SM1 (1.035"-40)			

a. Please note that the SM1FCA has a mechanical angle of only 4°, even though the standard angle for these connectors is 8°. There is a 4° angle of deflection caused by the glass-air interface; when combined with the 4° mechanical angle, the output beam is aligned perpendicular to the adapter face.

Part Number	Description	Price	Availability
SM1FC	FC/PC Fiber Adapter Plate with External SM1 (1.035"-40) Thread	\$29.58	Today
SM1FCA	FC/APC Fiber Adapter Plate with External SM1 (1.035"-40) Thread	\$31.37	Today
SM1SMA	SMA Fiber Adapter Plate with External SM1 (1.035"-40) Thread	\$29.58	Today
SM1ST	ST/PC Fiber Adapter Plate with External SM1 (1.035"-40) Thread	\$28.42	Today





OUTPUT  
0-2V

**THORLABS**  
www.thorlabs.com

CE

**DET05D**  
InGaAs Biased Detector  
800 - 2600nm

BIAS  
OUT



## Biased InGaAs Detectors Responsivity

