

56 Sparta Avenue • Newton, New Jersey 07860
 (973) 300-3000 Sales • (973) 300-3600 Fax
 www.thorlabs.com



Part FCMH2-FCL - JUN 13 2019

Item # FCMH2-FCL was discontinued on JUN 13 2019. For informational purposes, this is a copy of the website content at that time and is valid only for the stated product.

FIBER OPTIC COUPLERS FOR OPTOGENETICS

- ▶ Use for Bilateral Stimulation with Two Implants
- ▶ 1x2 or 2x2 Configurations Available
- ▶ Inputs with FC/PC or SMA905 Connectors
- ▶ Outputs with Ø1.25 mm or Ø2.5 mm Ceramic Ferrules



[Hide Overview](#)

OVERVIEW

Features

- Couplers with 50:50 Split Ratio for Optogenetics Applications
- 1x2 Couplers
 - Split Light from a Single Source into Two Fiber Optic Implants for Dual Stimulation
 - Ø105 µm or Ø200 µm Core, 0.22 NA Multimode Fiber
- 2x2 Couplers
 - Split Light when Only One Input is Used
 - Combine Two Light Sources to Stimulate at Two Different Wavelengths Simultaneously
 - Ø200 µm Core, 0.39 NA Multimode Fiber
- Available with Ø1.25 µm or Ø2.5 mm Ceramic Ferrules on Output Ports for Compatibility with Optogenetics Cannulae
- SMA905 or 2.0 mm Narrow Key FC/PC Connectors on Input Port
- Use with Fiber-Coupled LED or Multimode Laser Light Source
- Custom Connector Options Available; Contact Tech Support with Requests

MM Couplers for Optogenetics
1x2 Ø105 µm Core, 0.22 NA
1x2 Ø200 µm Core, 0.22 NA
2x2 Ø200 µm Core, 0.39 NA

Optogenetics Selection Guide
Optogenetics Overview
Fiber Optic Cannulae
Stereotaxic Cannula Holders and Adapter Arms
Cannula Implant Guides
Rotary Joint Patch Cables
Lightweight Patch Cables
1x1 Rotary Joint
Interconnect and Mating Sleeves
Multimode Fiber Couplers
1x2 Rotary Joint Splitter
LED Light Sources
Laser Light Source
Customizable Optogenetics Kits

These 1x2 and 2x2 Multimode Fiber Optic Couplers/Splitters are designed to split or combine light over a broad wavelength range at a 50:50 ratio and are optimized for Optogenetics. The 1x2 couplers are available with Ø105 µm or Ø200 µm, 0.22 NA, low-OH multimode fiber while 2x2 couplers are available with FT200UMT Ø200 µm, 0.39 NA, high-OH fiber.

Both 1x2 and 2x2 couplers can be used to split light from a single source evenly into the two output legs (shown in the diagram below). Unlike a fiber bundle, both fiber-coupled LEDs or multimode lasers can be used as the light source. This configuration is commonly used for bilateral stimulation where two fiber optic implants need to be illuminated using a single light source.

2x2 couplers can also be used in simultaneous stimulation applications where two light sources are combined in a single fiber to illuminate at two wavelengths using a single implant. However, both signals will experience approximately a 40% typical transmission, as each input signal will be evenly split between the two output ports, plus a small percentage of light will be attenuated within the coupler.

Mating Sleeve and Patch Cable Compatibility

Choose from either SMA or FC/PC connectors on the input legs for connection to a light source. Options for output terminations include Ø1.25 mm and Ø2.5 mm ceramic ferrules. The ferrule diameter of a patch cable and cannula is the key factor for physical compatibility with an interconnect and mating sleeve. Mixing stainless steel and ceramic ferrules should not introduce significant additional signal losses. Cannulae and patch cables using Ø1.25 mm ferrules can be connected using the ADAL1 mating sleeve or ADAL3 interconnect. Components with Ø2.5 mm ferrules can be connected using the ADAF1 mating sleeve or ADAF2 interconnect.

Each coupler includes protective caps that shield the ferrule ends from dust and other hazards. Additional CAPL Fiber Caps for Ø1.25 mm ferrule ends, CAPF Fiber Caps for FC/PC-terminated and Ø2.5 mm ferrule ends, and CAPM Rubber Caps for SMA-terminated ends are also sold separately. If the fiber ends become dirty from use, we offer a selection of inspection tools, as well as fiber optic cleaning products.

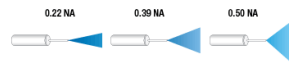

Click to Enlarge
 The NA of the fiber used in patch cables and cannulae affects the divergence angle of the beam. Multiple fiber NAs are available across our optogenetics product line.

Launch Conditions and Coupler Performance

When launching light from a source such as a fiber-coupled LED into a multimode fiber using a butt-coupling setup, it is common for some of the light to be coupled into the fiber's cladding instead of the core. Please note that light coupled into the cladding will not be transmitted through these couplers. All specifications apply to light in the fiber's core only. For additional information on mode fill when using an LED source, please refer to the *MM Fiber Tutorial* tab. For best performance, choose a patch cable and cannula with the same fiber core diameter and NA.

Optogenetics Product Family for *In Vivo* Applications

The image below shows an example bilateral stimulation optogenetic system using a 1x2 multimode coupler. Thorlabs offers a wide variety of products designed to support *in vivo* optogenetics applications. Please visit the *OG Selection Guide* tab above to see a full listing of available products for different applications.

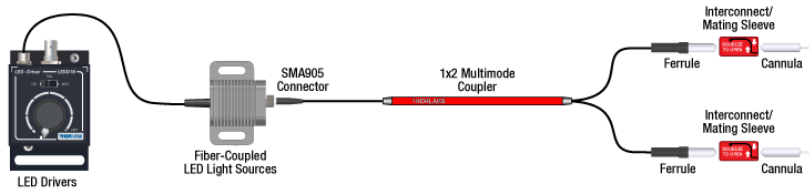

[Hide 1x2 Coupler Tutorial](#)

1 X 2 COUPLER TUTORIAL & NBSP ;

Definition of 1x2 Fused Fiber Optic Coupler Specifications

This tab provides a brief explanation of how we determine several key specifications for our 1x2 couplers. 1x2 couplers are manufactured using the same process as our 2x2 fiber optic couplers, except the second input port is internally terminated using a proprietary method that minimizes back reflections. For combining light of different wavelengths, Thorlabs offers a line of single mode wavelength division multiplexers (WDMs). The ports on our 1x2 couplers are configured as shown in the schematic below.

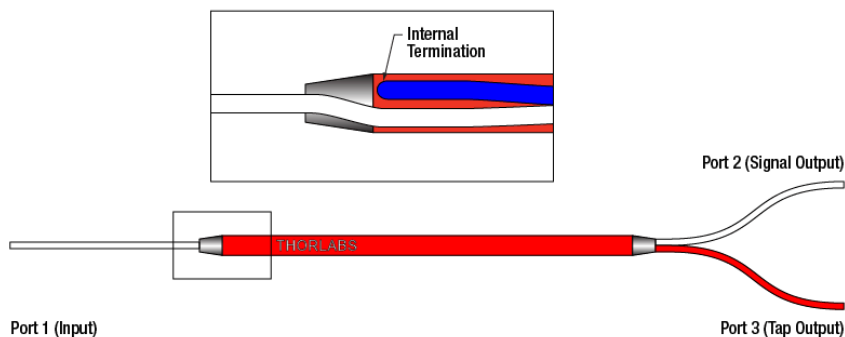

Excess Loss

Excess loss in dB is determined by the ratio of the total input power to the total output power:

$$\text{Excess Loss}(dB) = 10 \log \frac{P_{port1}(mW)}{P_{port2}(mW) + P_{port3}(mW)}$$

P_{port1} is the input power at port 1 and $P_{port2} + P_{port3}$ is the total output power from Ports 2 and 3. All powers are expressed in mW.

Polarization Dependent Loss (PDL)

The polarization dependent loss is defined as the ratio of the maximum and minimum transmissions due to polarization states in couplers. This specification pertains only to couplers not designed for maintaining polarization. PDL is always specified in decibels (dB), and can be calculated with the following equation:

$$\text{Polarization Dependent Loss}(dB) = 10 \log \frac{P_{max}(mW)}{P_{min}(mW)}$$

where P_{max} is the maximum power able to be transmitted through the coupler when scanning across all possible polarization states. P_{min} is the minimum transmission across those same states.

Optical Return Loss (ORL) / Directivity

The directivity refers to the fraction of input light that is lost in the internally terminated fiber end within the coupler housing when port 1 is used as the input. It

can be calculated in units of dB using the following equation:

$$\text{Directivity}(dB) = 10 \log \frac{P_{\text{port1b}}(mW)}{P_{\text{port1}}(mW)}$$

where P_{port1} and P_{port1b} are the optical powers (in mW) in port 1 and the internally terminated fiber, respectively. This output is the result of back reflection at the junction of the legs of the coupler and represents a loss in the total light output at ports 2 and 3. For a 50:50 coupler, the directivity is equal to the optical return loss (ORL).

Insertion Loss

The insertion loss is defined as the ratio of the input power to the output power at one of the output legs of the coupler (signal or tap). Insertion loss is always specified in decibels (dB). It is generally defined using the equation below:

$$\text{Insertion Loss}(dB) = 10 \log \frac{P_{\text{in}}(mW)}{P_{\text{out}}(mW)}$$

where P_{in} and P_{out} are the input and output powers (in mW). For our 1x2 couplers, the insertion loss specification is provided for both signal and tap outputs; our specifications always list insertion loss for the signal output first. To define the insertion loss for a specific output (port 2 or port 3), the equation is rewritten as:

$$\text{Insertion Loss}_{\text{port1} \rightarrow \text{port2}}(dB) = 10 \log \frac{P_{\text{port1}}(mW)}{P_{\text{port2}}(mW)}$$

$$\text{Insertion Loss}_{\text{port1} \rightarrow \text{port3}}(dB) = 10 \log \frac{P_{\text{port1}}(mW)}{P_{\text{port3}}(mW)}$$

Insertion loss inherently includes both coupling (e.g., light transferred to the other output leg) and excess loss (e.g., light lost from the coupler) effects. The maximum allowed insertion loss for each output, signal and tap, are both specified. Because the insertion loss in each output is correlated to light coupled to the other output, no coupler will ever have the maximum insertion loss in both outputs simultaneously.

Calculating Insertion Loss using Power Expressed in dBm

Insertion loss can also be easily calculated with the power expressed in units of dBm. The equation below shows the relationship between power expressed in mW and dBm:

$$P(dBm) = 10 \log P(mW)$$

Then, the insertion loss in dB can be calculated as follows:

$$\text{Insertion Loss}(dB) = P_{\text{in}}(dBm) - P_{\text{out}}(dBm)$$

Coupling Ratio

Insertion loss (in dB) is the ratio of the input power to the output power from each leg of the coupler as a function of wavelength. It captures both the coupling ratio and the excess loss. The coupling ratio is calculated from the measured insertion loss. Coupling ratio (in %) is the ratio of the optical power from each output port (ports 2 and 3) to the sum of the total power of both output ports as a function of wavelength. Path A represents light traveling from port 1 to port 2 while Path B represents light traveling from port 1 to port 3. It is not impacted by spectral features such as the water absorption region because both output legs are affected equally.

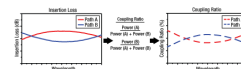

Click to Enlarge
A graphical representation of the coupling ratio calculation.

Uniformity

The uniformity is also calculated from the measured insertion loss. Uniformity is the variation (in dB) of the insertion loss over the bandwidth. It is a measure of how evenly the insertion loss is distributed over the spectral range. The uniformity of Path A is the difference between the value of highest insertion loss and the solid red insertion loss curve (in the Insertion Plot above). The uniformity of Path B is the difference between the solid blue insertion loss curve and the value of lowest insertion loss.

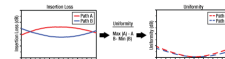

Click to Enlarge
A graphical representation of the Uniformity calculation.

[Hide 2x2 Coupler Tutorial](#)

2 X 2 COUPLER TUTORIAL

Definition of 2x2 Fused Fiber Optic Coupler Specifications

This tab provides a brief explanation of how we determine several key specifications for our 2x2 couplers. The ports of the coupler are defined as shown in the coupler schematic below. In the sections below, the light is input into port 1. Port 3 and port 4 would then be considered the signal and tap outputs, respectively.

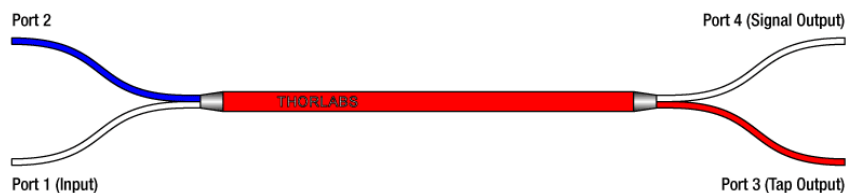

Excess Loss

Excess loss in dB is determined by the ratio of the total input power to the total output power:

$$\text{Excess Loss}(dB) = 10 \log \frac{P_{\text{port1}}(mW)}{P_{\text{port3}}(mW) + P_{\text{port4}}(mW)}$$

P_{port1} is the input power at port 1 and $P_{\text{port3}}+P_{\text{port4}}$ is the total output power from ports 3 and 4, assuming no input power at port 2. All powers are expressed in mW.

Polarization Dependent Loss (PDL)

The polarization dependent loss is defined as the ratio of the maximum and minimum transmissions due to polarization states in couplers. This specification pertains only to couplers not designed for maintaining polarization. PDL is always specified in decibels (dB), and can be calculated with the following equation:

$$\text{Polarization Dependent Loss}(dB) = 10 \log \frac{P_{\text{max}}(mW)}{P_{\text{min}}(mW)}$$

where P_{max} is the maximum power able to be transmitted through the coupler when scanning across all possible polarization states. P_{min} is the minimum transmission across those same states.

Optical Return Loss (ORL) / Directivity

The directivity refers to the fraction of input light that exits the coupler through an input port (i.e., light exiting at port 2) instead of the intended output port. It can be calculated in units of dB using the following equation:

$$\text{Directivity}(dB) = 10 \log \frac{P_{\text{port1}}(mW)}{P_{\text{port2}}(mW)}$$

where P_{port1} and P_{port2} are the optical powers (in mW) in port 1 and port 2, respectively. This output is the result of back reflection at the junction of the legs of the coupler and represents a loss in the total light output at ports 3 and 4. For a 50:50 coupler, the directivity is equal to the optical return loss (ORL).

Insertion Loss

The insertion loss is defined as the ratio of the input power to the output power at one of the output legs of the coupler (signal or tap). Insertion loss is always specified in decibels (dB). It is generally defined using the equation below:

$$\text{Insertion Loss}(dB) = 10 \log \frac{P_{\text{in}}(mW)}{P_{\text{out}}(mW)}$$

where P_{in} and P_{out} are the input and output powers (in mW). For our 2x2 couplers, the insertion loss specification is provided for both signal and tap outputs; our specifications always list insertion loss for the signal output first. To define the insertion loss for a specific output (port 3 or port 4), the equation is rewritten as:

$$\text{Insertion Loss}_{\text{port1} \rightarrow \text{port3}}(dB) = 10 \log \frac{P_{\text{port1}}(mW)}{P_{\text{port3}}(mW)}$$

$$\text{Insertion Loss}_{\text{port1} \rightarrow \text{port4}}(\text{dB}) = 10 \log \frac{P_{\text{port1}}(\text{mW})}{P_{\text{port4}}(\text{mW})}$$

A similar equation can be used to define the insertion loss at port 2 for input at port 1. However, as seen above, this is already defined as the directivity of the coupler.

Insertion loss inherently includes both coupling (e.g., light transferred to the other output leg) and excess loss (e.g., light lost from the coupler) effects. The maximum allowed insertion loss for each output, signal and tap, are both specified. Because the insertion loss in each output is correlated to light coupled to the other output, no coupler will ever have the maximum insertion loss in both outputs simultaneously.

Calculating Insertion Loss using Power Expressed in dBm

Insertion loss can also be easily calculated with the power expressed in units of dBm. The equation below shows the relationship between power expressed in mW and dBm:

$$P(\text{dBm}) = 10 \log P(\text{mW})$$

Then, the insertion loss in dB can be calculated as follows:

$$\text{Insertion Loss}(\text{dB}) = P_{\text{in}}(\text{dBm}) - P_{\text{out}}(\text{dBm})$$

Coupling Ratio

Insertion loss (in dB) is the ratio of the input power to the output power from each leg of the coupler as a function of wavelength. It captures both the coupling ratio and the excess loss. The coupling ratio is calculated from the measured insertion loss. Coupling ratio (in %) is the ratio of the optical power from each output port (A and B) to the sum of the total power of both output ports as a function of wavelength. It is not impacted by spectral features such as the water absorption region because both output legs are affected equally.

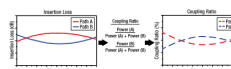

[Click to Enlarge](#)
A graphical representation of the coupling ratio calculation.

Uniformity

The uniformity is also calculated from the measured insertion loss. Uniformity is the variation (in dB) of the insertion loss over the bandwidth. It is a measure of how evenly the insertion loss is distributed over the spectral range. The uniformity of Path A is the difference between the value of highest insertion loss and the solid red insertion loss curve (in the Insertion Plot above). The uniformity of Path B is the difference between the solid blue insertion loss curve and the value of lowest insertion loss.

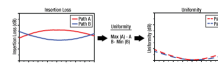

[Click to Enlarge](#)
A graphical representation of the Uniformity calculation.

[Hide MM Fiber Tutorial](#)

MM FIBER TUTORIAL

Guiding Light in an Optical Fiber

Optical fibers are part of a broader class of optical components known as waveguides that utilize total internal reflection (TIR) in order to confine and guide light within a solid or liquid structure. Optical fibers, in particular, are used in numerous applications; common examples include telecommunications, spectroscopy, illumination, and sensors.

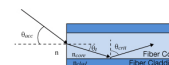

[Click to Enlarge](#)
Total Internal Reflection in an Optical Fiber

One of the more common glass (silica) optical fibers uses a structure known as a step-index fiber, which is shown in the image to the right. Step-index fibers have an inner core made from a material with a refractive index that is higher than the surrounding cladding layer. Within the fiber, a critical angle of incidence exists such that light will reflect off the core/cladding interface rather than refract into the surrounding medium. To fulfill the conditions for TIR in the fiber, the angle of incidence of light launched into the fiber must be less than a certain angle, which is defined as the acceptance angle, θ_{acc} . Snell's law can be used to calculate this angle:

$$\sin \theta_{\text{crit}} = \frac{n_{\text{clad}}}{n_{\text{core}}} = \cos \theta_t$$

$$n \sin \theta_{\text{acc}} = n_{\text{core}} \sqrt{1 - \cos^2 \theta_t} = \sqrt{n_{\text{core}}^2 - n_{\text{clad}}^2}$$

where n_{core} is the refractive index of the fiber core, n_{clad} is the refractive index of the fiber cladding, n is the refractive index of the outside medium, θ_{crit} is the critical angle, and θ_{acc} is the acceptance half-angle of the fiber. The numerical aperture (NA) is a dimensionless quantity used by fiber manufacturers to specify the acceptance angle of an optical fiber and is defined as:

$$NA = n \sin \theta_{\text{acc}} = \sqrt{n_{\text{core}}^2 - n_{\text{clad}}^2}$$

In step-index fibers with a large core (multimode), the NA can be calculated directly using this equation. The NA can also be determined experimentally by tracing the far-field beam profile and measuring the angle between the center of the beam and the point at which the beam intensity is 5% of the maximum; however, calculating the NA directly provides the most accurate value.

Number of Modes in an Optical Fiber

Each potential path that light propagates through in an optical fiber is known as a guided mode of the fiber. Depending on the physical dimensions of the core/cladding regions, refractive index, and wavelength, anything from one to thousands of modes can be supported within a single optical fiber. The two most commonly manufactured variants are single mode fiber (which supports a single guided mode) and multimode fiber (which supports a large number of guided modes). In a multimode fiber, lower-order modes tend to confine light spatially in the core of the fiber; higher-order modes, on the other hand, tend to confine light spatially near the core/cladding interface.

Using a few simple calculations, it is possible to estimate the number of modes (single mode or multimode) supported by an optical fiber. The normalized optical frequency, also known as the V-number, is a dimensionless quantity that is proportional to the free space optical frequency but is normalized to guiding properties of an optical fiber. The V-number is defined as:

$$V = \frac{2\pi a}{\lambda} NA$$

where V is the normalized frequency (V-number), a is the fiber core radius, and λ is the free space wavelength. Multimode fibers have very large V-numbers; for example, a $\varnothing 50 \mu\text{m}$ core, 0.39 NA multimode fiber at a wavelength of $1.5 \mu\text{m}$ has a V-number of 40.8.

For multimode fiber, which has a large V-number, the number of modes supported is approximated using the following relationship.

$$M \approx \frac{V^2}{2}$$

In the example above of the $\varnothing 50 \mu\text{m}$ core, 0.39 NA multimode fiber, it supports approximately 832 different guided modes that can all travel simultaneously through the fiber.

Single mode fibers are defined with a V-number cut-off of $V < 2.405$, which represents the point at which light is coupled only into the fiber's fundamental mode. To meet this condition, a single mode fiber has a much smaller core size and NA compared to a multimode fiber at the same wavelength. One example of this, SMF-28 Ultra single mode fiber, has a nominal NA of 0.14 and an $\varnothing 8.2 \mu\text{m}$ core at 1550 nm , which results in a V-number of 2.404.

Sources of Attenuation

Loss within an optical fiber, also referred to as attenuation, is characterized and quantified in order to predict the total transmitted power lost within a fiber optic setup. The sources of these losses are typically wavelength dependent and range from the material used in the fiber itself to bending of the fiber. Common sources of attenuation are detailed below:

Absorption

Because light in a standard optical fiber is guided via a solid material, there are losses due to absorption as light propagates through the fiber. Standard fibers are manufactured using fused silica and are optimized for transmission from 1300 nm to 1550 nm . At longer wavelengths ($>2000 \text{ nm}$), multi-phonon interactions in fused silica cause significant absorption. Fluoride glasses such as ZrF_4 and InF_3 are used in manufacturing Mid-IR optical fibers primarily because they exhibit lower loss at these wavelengths. ZrF_4 and InF_3 fibers have a multi-phonon edge of $\sim 3.6 \mu\text{m}$ and $\sim 4.6 \mu\text{m}$, respectively.

Contaminants in the fiber also contribute to the absorption loss. One example of an undesired impurity is water molecules that are trapped in the glass of the optical fiber, which will absorb light around 1300 nm and $2.94 \mu\text{m}$. Since telecom signals and some lasers operate in that same region, any water molecules present in the fiber will attenuate the signal significantly.

The concentration of ions in the fiber glass is often controlled by manufacturers to tune the transmission/attenuation properties of a fiber. For example, hydroxyl ions (OH^-) are naturally present in silica and absorb light in the NIR-IR spectrum. Therefore, fibers with low-OH content are preferred for transmission at telecom wavelengths. On the other hand, fibers with high-OH content typically exhibit increased transmission at UV wavelengths and thus may be preferred by users interested in applications such as fluorescence or UV-VIS spectroscopy.

Scattering

For the majority of fiber optics applications, light scattering is a source of loss that occurs when light encounters a change in the refractive index of the medium. These changes can be extrinsic, caused by impurities, particulates, or bubbles; or intrinsic, caused by fluctuations in the glass density, composition, or phase state. Scattering is inversely related to the wavelength of light, so scattering loss becomes significant at shorter wavelengths such as the UV or blue regions of the spectrum. Using proper fiber cleaning, handling, and storage procedures may minimize the presence of impurities on tips of fibers that cause large scattering losses.

Bending Loss

Losses that occur due to changes in the external and internal geometry of an optical fiber are known as bending loss. These are usually separated into two categories: macrobending loss and microbending loss.

Macrobend loss is typically associated with the physical bending of an optical fiber; for example, rolling it in a tight coil. As shown in the image to the right, guided light is spatially distributed within the core and cladding regions of the fiber. When a fiber is bent at a radius, light near the outer radius of the bend cannot maintain the same spatial mode profile without exceeding the speed of light. Instead, the energy is lost to the surroundings as radiation. For a large bend radius, the losses associated with bending are small; however, at bend radii smaller than the recommended bend radius of a fiber, bend losses become very significant. For short periods of time, optical fibers can be operated at a small bend radius; however, for long-term storage, the bend radius should be larger than the recommended value. Use proper storage conditions (temperature and bend radius) to reduce the likelihood of permanently damaging the fiber; the FSR1 Fiber Storage Reel is designed to minimize high bend loss.



Click to Enlarge
Attenuation Due to
Macrobend Loss

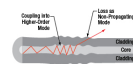

Click to Enlarge
Attenuation Due to
Microbend Loss

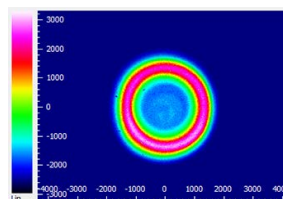

Click to Enlarge
Beam profile measurement of FT200EMT multimode fiber and a former generation M565F1 LED (replaced by the M565F3) showing light guided in the cladding rather than the core of the fiber.

Microbend loss arises from changes in the internal geometry of the fiber, particularly the core and cladding layers. These random variations (i.e., bumps) in the fiber structure disturb the conditions needed for total internal reflection, causing propagating light to couple into a non-propagating mode that leaks from the fiber (see the image to the right for details). Unlike macrobend loss, which is controlled by the bend radius, microbend loss occurs due to permanent defects in the fiber that are created during fiber manufacturing.

Cladding Modes

While most light in a multimode fiber is guided via TIR within the core of the fiber, higher-order modes that guide light within both the core and cladding layer, because of TIR at the cladding and coating/buffer interface, can also exist. This results in what is known as a cladding mode. An example of this can be seen in the beam profile measurement to the right, which shows cladding modes with a higher intensity in the cladding than in the core of the fiber. These modes can be non-propagating (i.e., they do not fulfill the conditions for TIR) or they can propagate over a significant length of fiber. Because cladding modes are typically higher-order, they are a source of loss in the presence of fiber bending and microbending defects. Cladding modes are also lost when connecting two fibers via connectors as they cannot be easily coupled between optical fibers.

Cladding modes may be undesired for some applications (e.g., launching into free space) because of their effect on the beam spatial profile. Over long fiber lengths, these modes will naturally attenuate. For short fiber lengths (<10 m), one method for removing cladding modes from a fiber is to use a mandrel wrap at a radius that removes cladding modes while keeping the desired propagating modes.

Launch Conditions

Underfilled Launch Condition

For a large multimode fiber which accepts light over a wide NA, the condition of the light (e.g., source type, beam diameter, NA) coupled into the fiber can have a significant effect on performance. An underfilled launch condition occurs when the beam diameter and NA of light at the coupling interface are smaller than the core diameter and NA of the fiber. A common example of this is launching a laser source into a large multimode fiber. As seen in the diagram and beam profile measurement below, underfilled launches tend to concentrate light spatially in the center of the fiber, filling lower-order modes preferentially over higher-order modes. As a result, they are less sensitive to macrobend losses and do not have cladding modes. The measured insertion loss for an underfilled launch tends to be lower than typical, with a higher power density in the core of the fiber.

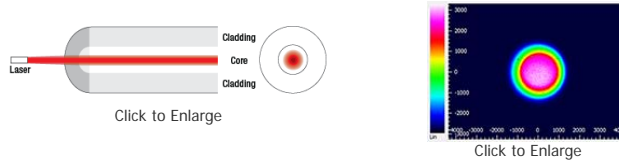

Diagram illustrating an underfilled launch condition (left) and a beam profile measurement using a FT200EMT multimode fiber (right).

Overfilled Launch Condition

Overfilled launches are defined by situations where the beam diameter and NA at the coupling interface are larger than the core diameter and NA of the fiber. One method to achieve this is by launching light from an LED source into a small multimode fiber. An overfilled launch completely exposes the fiber core and some of the cladding to light, enabling the filling of lower- and higher-order modes equally (as seen in the images below) and increasing the likelihood of coupling into cladding modes of the fiber. This increased percentage of higher-order modes means that overfilled fibers are more sensitive to bending loss. The measured insertion loss for an overfilled launch tends to be higher than typical, but results in an overall higher output power compared to an underfilled fiber launch.

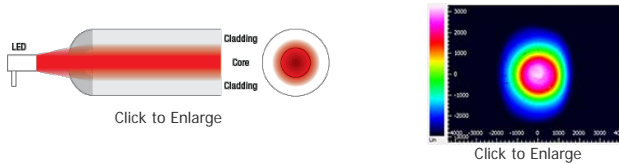

Diagram illustrating an overfilled launch condition (left) and a beam profile measurement using a FT200EMT multimode fiber (right).

There are advantages and disadvantages to underfilled or overfilled launch conditions, depending on the needs of the intended application. For measuring the baseline performance of a multimode fiber, Thorlabs recommends using a launch condition where the beam diameter is 70-80% of the fiber core diameter. Over short distances, an overfilled fiber has more output power; however, over long distances (>10 - 20 m) the higher-order modes that more susceptible to attenuation will disappear.

[Hide Damage Threshold](#)

DAMAGE THRESHOLD

Laser-Induced Damage in Silica Optical Fibers

The following tutorial details damage mechanisms relevant to unterminated (bare) fiber, terminated optical fiber, and other fiber components from laser light sources. These mechanisms include damage that occurs at the air / glass interface (when free-space coupling or when using connectors) and in the optical fiber itself. A fiber component, such as a bare fiber, patch cable, or fused coupler, may have multiple potential avenues for damage (e.g., connectors, fiber end faces, and the device itself). The maximum power that a fiber can handle will always be limited by the lowest limit of any of these damage mechanisms.

Quick Links
Damage at the Air / Glass Interface
Intrinsic Damage Threshold
Preparation and Handling of Optical Fibers

While the damage threshold can be estimated using scaling relations and general rules, absolute damage thresholds in optical fibers are very application dependent and user specific. Users can use this guide to estimate a safe power level that minimizes the risk of damage. Following all appropriate preparation and handling guidelines, users should be able to operate a fiber component up to the specified maximum power level; if no maximum is specified for a component, users should abide by the "practical safe level" described below for safe operation of the component. Factors that can reduce power handling and cause damage to a fiber component include, but are not limited to, misalignment during fiber coupling, contamination of the fiber end face, or imperfections in the fiber itself. For further discussion about an optical fiber's power handling abilities for a specific application, please contact Thorlabs' Tech Support.

Damage at the Air / Glass Interface

There are several potential damage mechanisms that can occur at the air / glass interface. Light is incident on this interface when free-space coupling or when two fibers are mated using optical connectors. High-intensity light can damage the end face leading to reduced power handling and permanent damage to the fiber. For fibers terminated with optical connectors where the connectors are fixed to the fiber ends using epoxy, the heat generated by high-intensity light can burn the epoxy and leave residues on the fiber facet directly in the beam path.

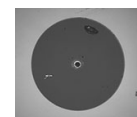

Click to Enlarge
Damaged Fiber End

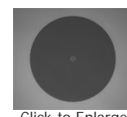

Click to Enlarge
Undamaged Fiber End

Damage Mechanisms on the Bare Fiber End Face

Damage mechanisms on a fiber end face can be modeled similarly to bulk optics, and industry-standard damage thresholds for UV Fused Silica substrates can be applied to silica-based fiber. However, unlike bulk optics, the relevant surface areas and beam diameters involved at the air / glass interface of an optical fiber are very small, particularly for coupling into single mode (SM) fiber. Therefore, for a given power density, the power incident on the fiber needs to be lower for a smaller beam diameter.

The table to the right lists two thresholds for optical power densities: a theoretical damage threshold and a "practical safe level". In general, the theoretical damage threshold represents the estimated maximum power density that can be incident on the fiber end face without risking damage with very good fiber end face and coupling conditions. The "practical safe level" power density represents minimal risk of fiber damage. Operating a fiber or component beyond the practical safe level is possible, but users must follow the appropriate handling instructions and verify performance at low powers prior to use.

Estimated Optical Power Densities on Air / Glass Interface ^a		
Type	Theoretical Damage Threshold ^b	Practical Safe Level ^c
CW (Average Power)	~1 MW/cm ²	~250 kW/cm ²
10 ns Pulsed (Peak Power)	~5 GW/cm ²	~1 GW/cm ²

- All values are specified for unterminated (bare) silica fiber and apply for free space coupling into a clean fiber end face.
- This is an estimated maximum power density that can be incident on a fiber end face without risking damage. Verification of the performance and reliability of fiber components in the system before operating at high power must be done by the user, as it is highly system dependent.
- This is the estimated safe optical power density that can be incident on a fiber end face without damaging the fiber under most operating conditions.

Calculating the Effective Area for Single Mode and Multimode Fibers

The effective area for single mode (SM) fiber is defined by the mode field diameter (MFD), which is the cross-sectional area through which light propagates in the fiber; this area includes the fiber core and also a portion of the cladding. To achieve good efficiency when coupling into a single mode fiber, the diameter of the input beam must match the MFD of the fiber.

As an example, SM400 single mode fiber has a mode field diameter (MFD) of ~Ø3 µm operating at 400 nm, while the MFD for SMF-28 Ultra single mode fiber operating at 1550 nm is Ø10.5 µm. The effective area for these fibers can be calculated as follows:

$$\text{SM400 Fiber: Area} = \pi \times (\text{MFD}/2)^2 = \pi \times (1.5 \mu\text{m})^2 = 7.07 \mu\text{m}^2 = 7.07 \times 10^{-8} \text{ cm}^2$$

$$\text{SMF-28 Ultra Fiber: Area} = \pi \times (\text{MFD}/2)^2 = \pi \times (5.25 \mu\text{m})^2 = 86.6 \mu\text{m}^2 = 8.66 \times 10^{-7} \text{ cm}^2$$

To estimate the power level that a fiber facet can handle, the power density is multiplied by the effective area. Please note that this calculation assumes a uniform intensity profile, but most laser beams exhibit a Gaussian-like shape within single mode fiber, resulting in a higher power density at the center of the beam compared to the edges. Therefore, these calculations will slightly overestimate the power corresponding to the damage threshold or the practical safe level. Using the estimated power densities assuming a CW light source, we can determine the corresponding power levels as:

$$\begin{aligned} \text{SM400 Fiber: } & 7.07 \times 10^{-8} \text{ cm}^2 \times 1 \text{ MW/cm}^2 = 7.1 \times 10^{-8} \text{ MW} = 71 \text{ mW (Theoretical Damage Threshold)} \\ & 7.07 \times 10^{-8} \text{ cm}^2 \times 250 \text{ kW/cm}^2 = 1.8 \times 10^{-5} \text{ kW} = 18 \text{ mW (Practical Safe Level)} \end{aligned}$$

$$\begin{aligned} \text{SMF-28 Ultra Fiber: } & 8.66 \times 10^{-7} \text{ cm}^2 \times 1 \text{ MW/cm}^2 = 8.7 \times 10^{-7} \text{ MW} = 870 \text{ mW (Theoretical Damage Threshold)} \\ & 8.66 \times 10^{-7} \text{ cm}^2 \times 250 \text{ kW/cm}^2 = 2.1 \times 10^{-4} \text{ kW} = 210 \text{ mW (Practical Safe Level)} \end{aligned}$$

The effective area of a multimode (MM) fiber is defined by the core diameter, which is typically far larger than the MFD of an SM fiber. For optimal coupling, Thorlabs recommends focusing a beam to a spot roughly 70 - 80% of the core diameter. The larger effective area of MM fibers lowers the power density on the fiber end face, allowing higher optical powers (typically on the order of kilowatts) to be coupled into multimode fiber without damage.

Damage Mechanisms Related to Ferrule / Connector Termination

Fibers terminated with optical connectors have additional power handling considerations. Fiber is typically terminated using epoxy to bond the fiber to a ceramic or steel ferrule. When light is coupled into the fiber through a connector, light that does not enter the core and propagate down the fiber is scattered into the outer layers of the fiber, into the ferrule, and the epoxy used to hold the fiber in the ferrule. If the light is intense enough, it can burn the epoxy, causing it to vaporize and deposit a residue on the face of the connector. This results in localized absorption sites on the fiber end face that reduce coupling efficiency and increase scattering, causing further damage.

For several reasons, epoxy-related damage is dependent on the wavelength. In general, light scatters more strongly at short wavelengths than at longer wavelengths. Misalignment when coupling is also more likely due to the small MFD of short-wavelength SM fiber that also produces more scattered light.

To minimize the risk of burning the epoxy, fiber connectors can be constructed to have an epoxy-free air gap between the optical fiber and ferrule near the fiber end face. Our high-power multimode fiber patch cables use connectors with this design feature.

Determining Power Handling with Multiple Damage Mechanisms

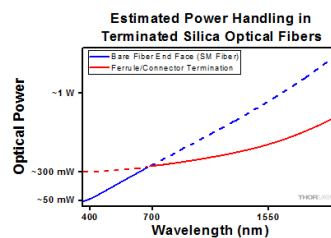

Click to Enlarge

Plot showing approximate input power that can be incident on a single mode silica optical fiber with a termination. Each line shows the estimated power level due to a specific damage mechanism. The maximum power handling is limited by the lowest power level from all relevant damage mechanisms (indicated by a solid line).

When fiber cables or components have multiple avenues for damage (e.g., fiber patch cables), the maximum power handling is always limited by the lowest damage threshold that is relevant to the fiber component. In general, this represents the highest input power that can be incident on the patch cable end face and not the coupled output power.

As an illustrative example, the graph to the right shows an estimate of the power handling limitations of a single mode fiber patch cable due to damage to the fiber end face and damage via an optical connector. The total input power handling of a terminated fiber at a given wavelength is limited by the lower of the two limitations at any given wavelength (indicated by the solid lines). A single mode fiber operating at around 488 nm is primarily limited by damage to the fiber end face (blue solid line), but fibers operating at 1550 nm are limited by damage to the optical connector (red solid line).

In the case of a multimode fiber, the effective mode area is defined by the core diameter, which is larger than the effective mode area for SM fiber. This results in a lower power density on the fiber end face and allows higher optical powers (on the order of kilowatts) to be coupled into the fiber without damage (not shown in graph). However, the damage limit of the ferrule / connector termination remains unchanged and as a result, the maximum power handling for a multimode fiber is limited by the ferrule and connector termination.

Please note that these are rough estimates of power levels where damage is very unlikely with proper handling and alignment procedures. It is worth noting that optical fibers are frequently used at power levels above those described here. However, these applications typically require expert users and testing at lower powers first to minimize risk of damage. Even still, optical fiber components should be considered a consumable lab supply if used at high power levels.

Intrinsic Damage Threshold

In addition to damage mechanisms at the air / glass interface, optical fibers also display power handling limitations due to damage mechanisms within the optical fiber itself. These limitations will affect all fiber components as they are intrinsic to the fiber itself. Two categories of damage within the fiber are damage from bend losses and damage from photodarkening.

Bend Losses

Bend losses occur when a fiber is bent to a point where light traveling in the core is incident on the core/cladding interface at an angle higher than the critical angle, making total internal reflection impossible. Under these circumstances, light escapes the fiber, often in a localized area. The light escaping the fiber typically has a high power density, which burns the fiber coating as well as any surrounding furcation tubing.

A special category of optical fiber, called double-clad fiber, can reduce the risk of bend-loss damage by allowing the fiber's cladding (2nd layer) to also function as a waveguide in addition to the core. By making the critical angle of the cladding/coating interface higher than the critical angle of the core/clad interface, light that escapes the core is loosely confined within the cladding. It will then leak out over a distance of centimeters or meters instead of at one localized spot within the fiber, minimizing the risk of damage. Thorlabs manufactures and sells 0.22 NA double-clad multimode fiber, which boasts very high, megawatt range power handling.

Photodarkening

A second damage mechanism, called photodarkening or solarization, can occur in fibers used with ultraviolet or short-wavelength visible light, particularly those with germanium-doped cores. Fibers used at these wavelengths will experience increased attenuation over time. The mechanism that causes photodarkening is largely unknown, but several fiber designs have been developed to mitigate it. For example, fibers with a very low hydroxyl ion (OH) content have been found to resist photodarkening and using other dopants, such as fluorine, can also reduce photodarkening.

Even with the above strategies in place, all fibers eventually experience photodarkening when used with UV or short-wavelength light, and thus, fibers used at these wavelengths should be considered consumables.

Preparation and Handling of Optical Fibers

General Cleaning and Operation Guidelines

These general cleaning and operation guidelines are recommended for all fiber optic products. Users should still follow specific guidelines for an individual product as outlined in the support documentation or manual. Damage threshold calculations only apply when all appropriate cleaning and handling procedures are followed.

1. All light sources should be turned off prior to installing or integrating optical fibers (terminated or bare). This ensures that focused beams of light are not incident on fragile parts of the connector or fiber, which can possibly cause damage.
2. The power-handling capability of an optical fiber is directly linked to the quality of the fiber/connector end face. Always inspect the fiber end prior to connecting the fiber to an optical system. The fiber end face should be clean and clear of dirt and other contaminants that can cause scattering of coupled light. Bare fiber should be cleaved prior to use and users should inspect the fiber end to ensure a good quality cleave is achieved.
3. If an optical fiber is to be spliced into the optical system, users should first verify that the splice is of good quality at a low optical power prior to high-power use. Poor splice quality may increase light scattering at the splice interface, which can be a source of fiber damage.
4. Users should use low power when aligning the system and optimizing coupling; this minimizes exposure of other parts of the fiber (other than the core) to light. Damage from scattered light can occur if a high power beam is focused on the cladding, coating, or connector.

Tips for Using Fiber at Higher Optical Power

Optical fibers and fiber components should generally be operated within safe power level limits, but under ideal conditions (very good optical alignment and very clean optical end faces), the power handling of a fiber component may be increased. Users must verify the performance and stability of a fiber component within their system prior to increasing input or output power and follow all necessary safety and operation instructions. The tips below are useful suggestions when considering increasing optical power in an optical fiber or component.

1. Splicing a fiber component into a system using a fiber splicer can increase power handling as it minimizes possibility of air/fiber interface damage. Users should follow all appropriate guidelines to prepare and make a high-quality fiber splice. Poor splices can lead to scattering or regions of highly localized heat at the splice interface that can damage the fiber.
2. After connecting the fiber or component, the system should be tested and aligned using a light source at low power. The system power can be ramped up slowly to the desired output power while periodically verifying all components are properly aligned and that coupling efficiency is not changing with respect to optical launch power.
3. Bend losses that result from sharply bending a fiber can cause light to leak from the fiber in the stressed area. When operating at high power, the localized heating that can occur when a large amount of light escapes a small localized area (the stressed region) can damage the fiber. Avoid

disturbing or accidentally bending fibers during operation to minimize bend losses.

- Users should always choose the appropriate optical fiber for a given application. For example, large-mode-area fibers are a good alternative to standard single mode fibers in high-power applications as they provide good beam quality with a larger MFD, decreasing the power density on the air/fiber interface.
- Step-index silica single mode fibers are normally not used for ultraviolet light or high-peak-power pulsed applications due to the high spatial power densities associated with these applications.

[Hide OG Selection Guide](#)

OG SELECTION GUIDE

Optogenetics Selection Guide

Thorlabs offers a wide range of optogenetics components; the compatibility of these products in select standard configurations is discussed in detail here. Please contact Technical Support for assistance with items outside the scope of this guide, including custom fiber components for optogenetics.

Quick Links
Single-Site Stimulation
One Light Source to One Cannula Implant
Bilateral Stimulation
One Light Source to Two Cannula Implants Using Rotary Joint Splitter
One or Two Light Sources to Two Cannula Implants
Two Light Sources into One Dual-Core Cannula Implant
Illumination
Fiber-Coupled LEDs and Drivers

Single-Site Stimulation

One Light Source to One Cannula Implant

The most straightforward method for *in vivo* light stimulation of a specimen is to use a single fiber optic with a single LED light source. The single wavelength LED is powered by an LED driver, and then the illumination output is fiber-coupled into a patch cable, which connects to the implanted cannula. See the graphics and expandable compatibility tables below for the necessary patch cables and cannulae to create this setup. To choose the appropriate LED and driver, see below or the full web presentation.

Click on Each Component for More Information

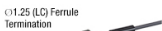
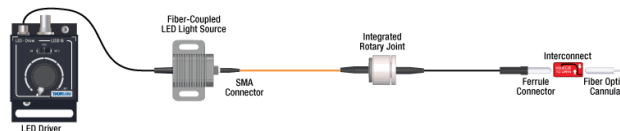

Click for Details

Click to See Ø1.25 mm (LC) Ferrule Compatible Patch Cables, Cannulae, and Interconnects

Component Selection Table (Click Links for Item Description Popup)							
Fiber Type		FG105LCA	FG200UCC	FT200EMT	FP200URT	FT400EMT	FP400URT
Fiber Type Specs	Core Diameter	105 µm	200 µm			400 µm	
	Wavelength Range	400 - 2400 nm	250 - 1200 nm	400 - 2200 nm	300 - 1200 nm	400 - 2200 nm	300 - 1200 nm
	NA	0.22	0.22	0.39	0.50	0.39	0.50
Component Selection Table (Click Links for Item Description Popup)							
Fiber Type		FG200UCC	FT200EMT	FP200URT	FT300EMT	FT400EMT	FP400URT
Fiber Type Specs	Core Diameter	200 µm			300 µm	400 µm	
	Wavelength Range	250 - 1200 nm	400 - 2200 nm	300 - 1200 nm	400 - 2200 nm	400 - 2200 nm	300 - 1200 nm
	NA	0.22	0.39	0.50	0.39	0.39	0.50
Patch Cables ^b	Standard FC/PC Input	M80L005 M80L01	M81L005 M81L01 MR81L01	M104L01	M56L005 M56L01	M82L005 M82L01	M128L01
	Standard SMA905 Input	M84L005 M84L01	M77L005 M77L01 MR77L01	M106L01	M58L005 M58L01	M79L005 M79L01	M126L01
	Rotary Joint FC/PC Input	-	RJAFF2 RJPF2	-	-	RJPFF4	-
	Rotary Joint SMA905 Input	-	RJASF2 RJPSF2	-	-	RJPSF4	-
Compatible Mating Sleeve/Interconnect		ADAF1 or ADAF2					
Fiber Optic	Ceramic 10.5 mm Long Ferrule	CFMC22L02	CFMC12L02	CFMC52L02	CFMC13L02	CFMC14L02	CFMC54L02
		CFMC22L05	CFMC12L05	CFMC52L05	CFMC13L05	CFMC14L05	CFMC54L05
		CFMC22L10	CFMC12L10	CFMC52L10	CFMC13L10	CFMC14L10	CFMC54L10
		CFMC22L20	CFMC12L20	CFMC52L20	CFMC13L20	CFMC14L20	CFMC54L20
		CFMC22U-20	CFMC12U-20	CFMC52U-20	CFMC13L20	CFMC14U-20	CFMC54L20

Fiber Optic Cannulae ^c	Diffuser Tip (Ceramic 6.4 mm Long Ferrule)				CFDSB02 CFDSB05 CFDSB10 CFDSB20		
	Ceramic 10.5 mm Long Ferrule		CFMXA02 CFMXA05 CFMXA10 CFMXA20	CFMXB02 CFMXB05 CFMXB10 CFMXB20	CFMXC02 CFMXC05 CFMXC10 CFMXC20		CFMXD02 CFMXD05 CFMXD10 CFMXD20
	Stainless Steel	CFML21L02 CFML21L05 CFML21L10 CFML21L20 CFML21U-20	CFML22L02 CFML22L05 CFML22L10 CFML22L20 CFML22U-20	CFML12L02 CFML12L05 CFML12L10 CFML12L20 CFML12U-20	CFML52L02 CFML52L05 CFML52L10 CFML52L20 CFML52U-20	CFML14L02 CFML14L05 CFML14L10 CFML14L20 CFML14U-20	

- a. Items are compatible with each other when they are comprised of the same fiber type and listed in the same column.
- b. Patch cables for single source to single implant applications are highlighted in green above. Choose a patch cable with an input that matches your light source.
- c. Available cannulae are highlighted in orange of the table above. Cannulae within the same column are interchangeable.

Ø2.5 (FC) Ferrule Termination



[Click for Details](#)

Click to See Ø2.5 mm (FC) Ferrule Compatible Patch Cables, Cannulae, and Interconnects

Component Selection Table (Click Links for Item Description Popup)							
Fiber Type		FG200UCC	FT200EMT	FP200URT	FT300EMT	FT400EMT	FP400URT
Fiber Type Specs	Core Diameter	200 µm			300 µm		400 µm
	Wavelength Range	250 - 1200 nm	400 - 2200 nm	300 - 1200 nm	400 - 2200 nm	400 - 2200 nm	300 - 1200 nm
	NA	0.22	0.39	0.50	0.39	0.39	0.50
Patch Cables ^b	Standard FC/PC Input	M80L005 M80L01	M81L005 M81L01 MR81L01	M104L01	M56L005 M56L01	M82L005 M82L01	M128L01
	Standard SMA905 Input	M84L005 M84L01	M77L005 M77L01 MR77L01	M106L01	M58L005 M58L01	M79L005 M79L01	M126L01
	Rotary Joint FC/PC Input	-	RJAFF2 RJPF2	-	-	RJPF4	-
	Rotary Joint SMA905 Input	-	RJASF2 RJPSF2	-	-	RJPSF4	-
Compatible Mating Sleeve/Interconnect		ADAF1 or ADAF2					
Fiber Optic Cannulae ^c	Ceramic 10.5 mm Long Ferrule	CFMC22L02 CFMC22L05 CFMC22L10 CFMC22L20 CFMC22U-20	CFMC12L02 CFMC12L05 CFMC12L10 CFMC12L20 CFMC12U-20	CFMC52L02 CFMC52L05 CFMC52L10 CFMC52L20 CFMC52U-20	CFMC13L02 CFMC13L05 CFMC13L10 CFMC13L20	CFMC14L02 CFMC14L05 CFMC14L10 CFMC14L20 CFMC14U-20	CFMC54L02 CFMC54L05 CFMC54L10 CFMC54L20
	Stainless Steel	CFM22L02 CFM22L05 CFM22L10 CFM22L20 CFM22U-20	CFM12L02 CFM12L05 CFM12L10 CFM12L20 CFM12U-20	CFM52L02 CFM52L05 CFM52L10 CFM52L20 CFM52U-20	CFM13L02 CFM13L05 CFM13L10 CFM13L20	CFM14L02 CFM14L05 CFM14L10 CFM14L20 CFM14U-20	-

- a. Items are compatible with each other when they are comprised of the same fiber type and listed in the same column.
- b. Patch cables for single source to single implant applications are highlighted in green above. Choose a patch cable with an input that matches your light source.
- c. Available cannulae are highlighted in orange of the table above. Cannulae within the same column are interchangeable.

Bilateral Stimulation

The ability to accurately and simultaneously direct light to multiple locations within a specimen is desired for many types of optogenetics experiments. For example, bilateral stimulation techniques typically target neurons in two spatially separated regions in order to induce a desired behavior. In more complex experiments involving the simultaneous inhibition and stimulation of neurons, delivering light of two different monochromatic wavelengths within close proximity enables the user to perform these experiments without implanting multiple cannulae, which can increase stress on the specimen.

Bilateral stimulation can be achieved with several different configurations depending on the application requirements. The sections below illustrate examples of different configurations using Thorlabs' optogenetics products.

Option 1: One Light Source to Two Cannula Implants Using Rotary Joint Splitter

Thorlabs' RJ2 1x2 Rotary Joint Splitter is designed for optogenetics applications and is used to split light from a single input evenly between two outputs. The rotary joint interface allows connected patch cables to freely rotate, reducing the risk of fiber damage caused by a moving specimen. See the graphic and compatibility table below for the necessary cables and cannulae to create this setup. For LEDs and drivers, see below or the [full web presentation](#).

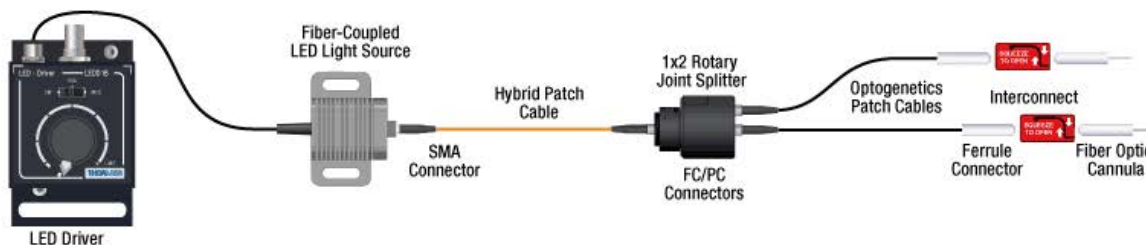

Ø1.25 (LC) Ferrule Termination



[Click for Details](#)

Click to See Ø1.25 mm (LC) Ferrule Components Recommended for Use with RJ2 Rotary Joint Splitter

Component Selection Table (Click Links for Item Description Popup)						
Common Fiber Properties						
Fiber Properties	Core Diameter	200 µm			400 µm	
	Wavelength Range ^a	400 - 700 nm	400 - 700 nm	400 - 700 nm	400 - 700 nm	400 - 700 nm
	NA	0.22	0.39	0.50	0.39	0.50
Input Patch Cables ^b	Standard FC/PC Connectors	M122L01 M122L02 M122L05	M72L01 M72L02 M72L05	M123L01 M123L02	M74L01 M74L02 M74L05	M124L01 M124L02
	Hybrid SMA905 to FC/PC	M36L01	M75L01 M75L02	M129L01 M129L02	M76L01 M76L02	M131L01 M131L02
Rotary Joint		RJ2				
Output Patch Cables	FC/PC to Ø1.25 mm (LC) Ferrule	M86L005 M86L01	M83L01 MR83L01	M73L01	M99L01	M127L01
Compatible Mating Sleeve/Interconnect		ADAL1 or ADAL3				
Fiber Optic Cannulae ^c	Ceramic 6.4 mm Long Ferrule	CFMFC22L02 CFMFC22L05 CFMFC22L10 CFMFC22L20 CFMFC22U-20	CFMFC12L02 CFMFC12L05 CFMFC12L10 CFMFC12L20 CFMFC12U-20	CFMFC52L02 CFMFC52L05 CFMFC52L10 CFMFC52L20 CFMFC52U-20	CFMFC14L02 CFMFC14L05 CFMFC14L10 CFMFC14L20 CFMFC14U-20	-
	Diffuser Tip (Ceramic 6.4 mm Long Ferrule)	-	CFDSB02 CFDSB05 CFDSB10 CFDSB20	-	-	-
	Ceramic 10.5 mm Long Ferrule	CFMXA02 CFMXA05 CFMXA10 CFMXA20	CFMXB02 CFMXB05 CFMXB10 CFMXB20	CFMXC02 CFMXC05 CFMXC10 CFMXC20	-	CFMXD02 CFMXD05 CFMXD10 CFMXD20
	Stainless Steel	CFML22L02 CFML22L05 CFML22L10 CFML22L20 CFML22U-20	CFML12L02 CFML12L05 CFML12L10 CFML12L20 CFML12U-20	CFML52L02 CFML52L05 CFML52L10 CFML52L20 CFML52U-20	CFML14L02 CFML14L05 CFML14L10 CFML14L20 CFML14U-20	-

- a. Products in each column can be used with each other over the indicated wavelength range and is limited by the operating range of the RJ2 Rotary Joint Splitter. Individual products may be used outside this range; see product information for detailed specifications.
- b. Use a standard FC/PC patch cable to connect to an FC/PC-terminated light source. SMA905 to FC/PC hybrid patch cables should be used to connect to an SMA905-terminated light source.
- c. Available cannulae are highlighted in orange of the table above. Cannulae within the same column are interchangeable.

Ø2.5 (FC) Ferrule Termination



[Click for Details](#)

Click to See Ø2.5 mm (FC) Ferrule Components Recommended for Use with RJ2 Rotary Joint Splitter

Component Selection Table (Click Links for Item Description Popup)							
Common Fiber Properties							
Fiber Properties	Core Diameter	200 µm			300 µm	400 µm	
	Wavelength Range ^a	400 - 700 nm	400 - 700 nm	400 - 700 nm	400 - 700 nm	400 - 700 nm	400 - 700 nm
	NA	0.22	0.39	0.50	0.39	0.39	0.50
Input Patch Cables	Standard FC/PC Connectors	M122L01 M122L02 M122L05	M72L01 M72L02 M72L05	M123L01 M123L02	M56L005 M56L01	M74L01 M74L02 M74L05	M124L01 M124L02
	Hybrid SMA905 to FC/PC	M36L01	M75L01 M75L02	M129L01 M129L02	M58L005 M58L01	M76L01 M76L02	M131L01 M131L02
Rotary Joint		RJ2					
Output Patch Cables	FC/PC to Ø2.5 mm (FC) Ferrule	M80L005 M80L01	M81L005 M81L01 MR81L01	M104L01	M56L005 M56L01	M82L005 M82L01	M128L01
Compatible Mating Sleeve/Interconnect		ADAF1 or ADAF2					
Fiber Optic Cannulae ^c	Ceramic 10.5 mm Long Ferrule	CFMFC22L02 CFMFC22L05 CFMFC22L10 CFMFC22L20 CFMFC22U-20	CFMFC12L02 CFMFC12L05 CFMFC12L10 CFMFC12L20 CFMFC12U-20	CFMFC52L02 CFMFC52L05 CFMFC52L10 CFMFC52L20 CFMFC52U-20	CFMFC13L02 CFMFC13L05 CFMFC13L10 CFMFC13L20	CFMFC14L02 CFMFC14L05 CFMFC14L10 CFMFC14L20 CFMFC14U-20	CFMFC54L02 CFMFC54L05 CFMFC54L10 CFMFC54L20
	Stainless Steel	CFM22L02 CFM22L05 CFM22L10 CFM22L20 CFM22U-20	CFM12L02 CFM12L05 CFM12L10 CFM12L20 CFM12U-20	CFM52L02 CFM52L05 CFM52L10 CFM52L20 CFM52U-20	CFM13L02 CFM13L05 CFM13L10 CFM13L20	CFM14L02 CFM14L05 CFM14L10 CFM14L20 CFM14U-20	-

- a. Products in each column can be used with each other over the indicated wavelength range and is limited by the operating range of the RJ2 Rotary Joint Splitter. Individual products may be used outside this range; see product information for detailed specifications.
- b. Use a standard FC/PC patch cable to connect to an FC/PC-terminated light source. SMA905 to FC/PC hybrid patch cables should be used to connect to an SMA905-terminated light source.
- c. Available cannulae are highlighted in orange of the table above. Cannulae within the same column are interchangeable.

Option 2: One or Two Light Sources to Two Cannula Implants

If the intent is for one LED source to connect to two cannulae for simultaneous light modulation, then a bifurcated fiber bundle can be used to split the light from the LED into each respective cannula. For dual wavelength stimulation (mixing two wavelengths in a single cannula) or a more controlled split ratio between cannula, one can use a multimode coupler to connect one or two LEDs to the cannulae. If one cable end is left unused, the spare coupler cable end may be terminated by a [light trap](#). See the graphic and compatibility table below for the necessary cables and cannulae to create this setup. For LEDs and drivers, see below or the [full web presentation](#).

Click on Each Component Below for More Information

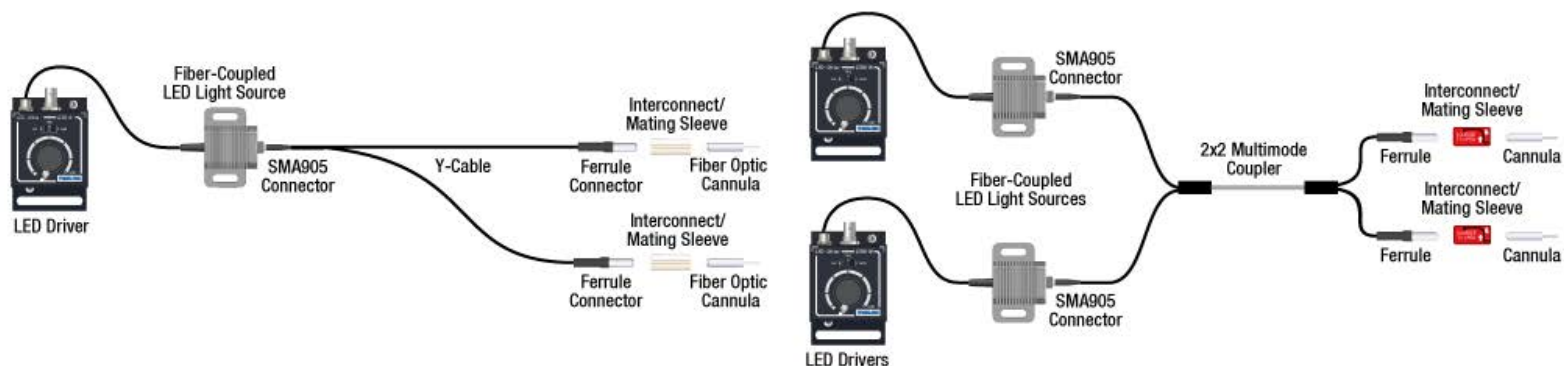

Click to see Compatible Fiber Bundles, Coupler/Splitters, Cannulae, and Interconnects

Part Selection Table (Click Links for Item Description Popup)

Common Fiber Properties									
Core Diameter		105 μm		200 μm				400 μm	
Wavelength Range		400 - 2200 nm ^a		400 - 1200 nm ^a		400 - 900 nm ^a		400 - 2200 nm	
NA		0.22		0.22		0.39		0.39	
Ferrule Style ^b		LC (\varnothing 1.25 mm)	FC (\varnothing 2.5 mm)	LC (\varnothing 1.25 mm)	FC (\varnothing 2.5 mm)	LC (\varnothing 1.25 mm)	FC (\varnothing 2.5 mm)	LC (\varnothing 1.25 mm)	FC (\varnothing 2.5 mm)
Bifurcated Y-Cable ^c	FC/PC Input	-	-	BFYL1LF01	BFYF1LF01	BFYL2LF01	BFYF2LF01	BFYL4LF01	BFYF4LF01
	SMA905 Input	-	-	BFYL1LS01	BFYF1LS01	BFYL2LS01	BFYF2LS01	BFYL4LS01	BFYF4LS01
1x2 Multimode Coupler ^c	FC/PC Input	TM105FL1B	TM105FS1B	TM200FL1B	TM200FS1B	-	-	-	-
	SMA905 Input	TM105SL1B	TM105SS1B	TM200SL1B	TM200SS1B	-	-	-	-
2x2 Multimode Coupler ^c	FC/PC Input	-	-	-	-	FCMH2-FCL	FCMH2-FCF	-	-
	SMA905 Input	-	-	-	-	FCMH2-SMAL	FCMH2-SMAF	-	-
Compatible Mating Sleeve/Interconnect		ADAL1 ADAL3	ADAF1 ADAF2	ADAL1 ADAL3	ADAF1 ADAF2	ADAL1 ADAL3	ADAF1 ADAF2	ADAL1 ADAL3	ADAF1 ADAF2
Fiber Optic Cannulae ^d	Ceramic 6.4 mm Long Ferrule	CFMLC21L02 CFMLC21L05 CFMLC21L10 CFMLC21L20 CFMLC21U-20	-	CFMLC22L02 CFMLC22L05 CFMLC22L10 CFMLC22L20 CFMLC22U-20	-	CFMLC12L02 CFMLC12L05 CFMLC12L10 CFMLC12L20 CFMLC12U-20	-	CFMLC14L02 CFMLC14L05 CFMLC14L10 CFMLC14L20 CFMLC14U-20	-
	Diffuser Tip (Ceramic 6.4 mm Long Ferrule)	-	-	-	-	CFDSB02 CFDSB05 CFDSB10 CFDSB20	-	-	
	Ceramic 10.5 mm Long Ferrule	-	-	CFMXA02 CFMXA05 CFMXA10 CFMXA20	CFMCA02 CFMCA05 CFMCA10 CFMCA20	CFMCA02 CFMCA05 CFMCA10 CFMCA20	CFMCA02 CFMCA05 CFMCA10 CFMCA20	-	CFMCA14L02 CFMCA14L05 CFMCA14L10 CFMCA14L20 CFMCA14U-20
	Stainless Steel	CFML21L02 CFML21L05 CFML21L10 CFML21L20 CFML21U-20	-	CFML22L02 CFML22L05 CFML22L10 CFML22L20 CFML22U-20	CFM22L02 CFM22L05 CFM22L10 CFM22L20 CFM22U-20	CFML12L02 CFML12L05 CFML12L10 CFML12L20 CFML12U-20	CFM12L02 CFM12L05 CFM12L10 CFM12L20 CFM12U-20	CFM14L02 CFM14L05 CFM14L10 CFM14L20 CFM14U-20	CFM14L02 CFM14L05 CFM14L10 CFM14L20 CFM14U-20

a. Products in this column can be used with each other over the indicated wavelength range. Individual products may be used outside this range; see product information for detailed specifications.

b. LC components have a \varnothing 1.25 mm ferrule end while FC components have a \varnothing 2.5 mm ferrule end. Items listed in the same "Ferrule Style" column are compatible with each other.

c. Optogenetics products for one or two light sources to two cannula implant applications are highlighted in green above. Choose a component with an input that matches your light source.

d. Available cannulae are highlighted in orange of the table above. Cannula within the same column are interchangeable.

Two Light Sources into One Dual-Core Cannula Implant

For bilateral stimulation applications where the two cannulas need to be placed in close proximity (within ~1 mm), Thorlabs offers dual-core patch cables and cannulae that are designed for this specific application. Each core is driven by a separate light source, enabling users to stimulate and/or suppress nerve cells in the same region of the specimen. See the graphic and compatibility table below for the necessary cables and cannulae to create this setup. For LEDs and drivers, see below or the [full web presentation](#).

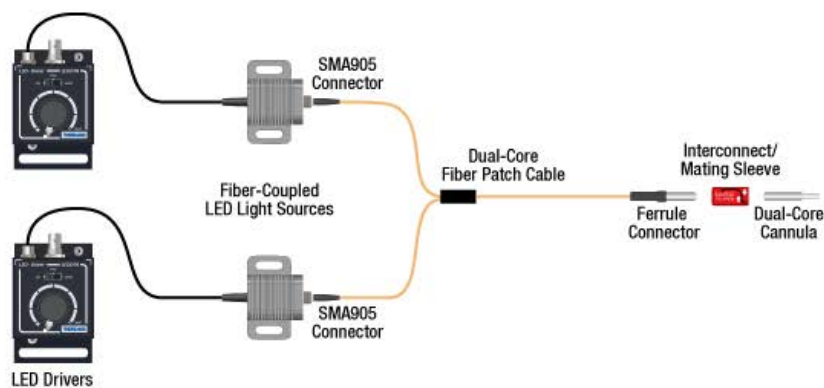

Part Selection Table (Click Links for Item Description Popup)		
Common Fiber Properties		
Core Diameter	200 μm	
Wavelength Range	400 - 2200 nm	
NA	0.39	
Fiber Type	FT200EMT	
Ferrule Style ^a	FC (\varnothing 2.5 mm)	
Dual-Core Patch Cable	FC/PC Input	BFY32FL1
	SMA905 Input	BFY32SL1
Compatible Mating Sleeve/Interconnect		ADAF1 ADAF2
Dual-Core Fiber Optic Cannulae ^c	Stainless Steel	CFM32L10 CFM32L20

- a. FC components have a \varnothing 2.5 mm ferrule end.
 b. Patch cables for dual light source to single implant applications are highlighted in green above. Choose a patch cable with an input that matches your light source.
 c. Available cannulae are highlighted in orange of the table above. Cannula within the same column are interchangeable.

Illumination

Fiber-Coupled LEDs and Drivers

Our [fiber-coupled LEDs](#) are ideal light sources for optogenetics applications. They feature a variety of wavelength choices and a convenient interconnection to optogenetics patch cables. Thorlabs offers fiber-coupled LEDs with nominal wavelengths ranging from 280 nm to 1050 nm. See the table to the right for the LEDs with the most popular wavelengths for optogenetics. A table of compatible LED drivers can be viewed by clicking below.



[Click to Enlarge](#)
M470F3

Popular Fiber-Coupled LEDs for Optogenetics

Item #	M470F3	M590F2
Center Wavelength	470 nm	590 nm
Bandwidth (FWHM)	20 nm	15 nm
Typical Output Spectrum (Click to Enlarge)		
\varnothing 200 μm Core Fiber Output (Typ.) ^a	7.0 mW	0.68 mW
\varnothing 400 μm Core Fiber Output (Typ.) ^b	21.8 mW	2.73 mW
CW Drive Current (Max)	1.0 A	1.0 A
LED Forward Voltage	3.1 V	2.8 V
Typical Lifetime	>50,000 Hours	>50,000 Hours

- a. Tested using MM Fiber with \varnothing 200 μm core, 0.22 NA (Item # [FG200UCC](#)).
 b. Tested using MM Fiber with \varnothing 400 μm core, 0.39 NA (Item # [FT400EMT](#)).

Click to See Compatible LED Drivers

Compatible Drivers ^a	LEDD1B ^b	DC2200 ^c	DC4100 ^{c,d,e}	DC4104 ^{c,d,e}
Click Photos to Enlarge				
Main Driver Features	Very Compact Footprint 60 mm x 73 mm x 104 mm (W x H x D)	Touchscreen Interface with Internal and External Options for Pulsed and Modulated LED Operation	4 Channels ^d	4 Channels ^d
LED Driver Current Output (Max)	1.2 A	LED1 Terminal: 10.0 A LED2 Terminal: 2.0 A ^f	1.0 A per Channel	1.0 A per Channel
LED Driver Forward Voltage (Max)	12 V	50 V	5 V	5 V
Modulation Frequency	0 to 5 kHz (External)	20 to 100 kHz (Internal) ^h DC to 250 kHz (External) ^{g,h}	0 to 100 kHz (External) ^h Simultaneous Across all Channels	0 to 100 kHz (External) ^h Independently Controlled Channels
External Control Interface(s)	Analog (BNC)	USB 2.0 and Analog (BNC)	USB 2.0 and Analog (BNC)	USB 2.0 and Analog (8-Pin)
EEPROM Compatible: Reads Out LED Data for LED Settings	-	✓	✓	✓
LCD Display	-	✓	✓	✓

- a. Click on the item number link to view the complete presentation for each controller.
 b. The preferred power supply (single channel or hub-based) depends on the end user's application and whether you already own compatible power supplies. To that end and in keeping with Thorlabs' green initiative, we do not ship the LEDD1B bundled with a power supply. This avoids the cost and inconvenience of receiving an unwanted single-channel supply if a hub-based system (Item # [KCH301](#) or [KCH601](#)) would be more appropriate.
 c. Automatically limits to LED's max current via EEPROM readout.
 d. The DC4100 and DC4104 can power and control up to four LEDs simultaneously when used with the DC4100-HUB. The fiber-coupled LEDs on this page all require the DC4100-HUB when used with the DC4100 or DC4104.
 e. These LED drivers have a maximum forward voltage rating of 5 V and can provide a maximum current of 1000 mA. As a result, they cannot be used to drive LEDs which have forward voltage ratings greater than 5 V. LEDs with maximum current ratings higher than 1.0 A can be driven using this driver, but will not reach full power.
 f. The fiber-coupled LEDs sold above are compatible with the LED2 Terminal.
 g. Small Signal Bandwidth: Modulation not exceeding 20% of full scale current. The driver accepts other waveforms, but the maximum frequency will be reduced.
 h. The M565F3 and M595F2 LEDs produce light by stimulating emission from phosphor, which limits their modulation frequency range. These LEDs may not turn off completely when modulated above 10 kHz at duty cycles below 50%.

Ø105 µm Core, 0.22 NA 1x2 Multimode Couplers



TM105FL1B

[Zoom](#)

- ▶ 1x2 Couplers with Ø105 µm, 0.22 NA Fiber
- ▶ SMA905 or FC/PC Connector on Input Port
- ▶ Ø1.25 mm or Ø2.5 mm Ceramic Ferrules on Output Ports
- ▶ Black Ø900 µm Loose Tubing Minimizes Light Leakage

These 1x2 couplers incorporate Ø105 µm, 0.22 NA multimode fiber and are designed for bilateral stimulation [optogenetics](#) applications where one light source is used to illuminate two fiber optic implants. They have SMA905 or FC/PC connectors on one side, and Ø1.25 mm or Ø2.5 mm ceramic ferrules on the other side, for connection to our [fiber optic cannulae](#). The fiber is jacketed in black Ø900 µm Hytrel[®] tubing to minimize light leakage from the fiber and with white or red heat-shrink wrap to indicate different ports. Thorlabs provides an individual data sheet for each coupler that contains measured test data verifying performance. A sample data sheet for these Ø105 µm core multimode couplers can be viewed [here](#).

Item #	Info	Wavelength Range	Coupling Ratio ^{a,b}	Insertion Loss ^{a,b}	Transmission ^a	Directivity ^a	Max Power Level ^c	Fiber ^d	Input Connector	Output Termination
TM105FL1B	i	400 - 2200 nm (Low OH)	50:50 ± 5.0%	≤4.1 dB / ≤4.1 dB	≥38.9% / ≥38.9%	≥50 dB	5 W (with Connectors)	Custom 0.22 NA Multimode Fiber	FC/PC	Ø1.25 mm Ceramic Ferrule
TM105SL1B	i								SMA905	
TM105FS1B	i								FC/PC	Ø2.5 mm Ceramic Ferrule
TM105SS1B	i								SMA905	

a. Specified at 650 nm and room temperature without connectors through the input port. The coupler can be used across its wavelength range, but performance may vary.

b. Please see the [1x2 Coupler Tutorial](#) tab for more information on these terms.

c. Specifies the total maximum power allowed through the component when mated using the input and output terminations.

d. For optimal performance, use with [patch cables](#) and [cannulae](#) that incorporate FG105LCA fiber.

Based on your currency / country selection, your order will ship from Newton, New Jersey

+1	Qty	Docs	Part Number - Universal	Price	Available
+	<input type="text"/>	d	TM105FL1B 1x2 MM Fiber Optic Coupler, Low OH, Ø105 µm Core, 0.22 NA, 50:50 Split, FC/PC to Ø1.25 mm Ceramic Ferrules	\$242.05	Today
+	<input type="text"/>	d	TM105SL1B 1x2 MM Fiber Optic Coupler, Low OH, Ø105 µm Core, 0.22 NA, 50:50 Split, SMA905 to Ø1.25 mm Ceramic Ferrules	\$262.65	Today
+	<input type="text"/>	d	TM105FS1B 1x2 MM Fiber Optic Coupler, Low OH, Ø105 µm Core, 0.22 NA, 50:50 Split, FC/PC to Ø2.5 mm Ceramic Ferrules	\$242.05	Today
+	<input type="text"/>	d	TM105SS1B 1x2 MM Fiber Optic Coupler, Low OH, Ø105 µm Core, 0.22 NA, 50:50 Split, SMA905 to Ø2.5 mm Ceramic Ferrules	\$262.65	Today

Add To Cart

Ø200 µm Core, 0.22 NA 1x2 Multimode Couplers

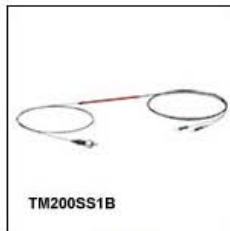

TM200SS1B

[Zoom](#)

- ▶ 1x2 Couplers with Ø200 µm, 0.22 NA Fiber
- ▶ SMA905 or FC/PC Connector on Input Port
- ▶ Ø1.25 mm or Ø2.5 mm Ceramic Ferrules on Output Ports
- ▶ Black Ø900 µm Loose Tubing Minimizes Light Leakage

These 1x2 couplers incorporate Ø200 µm, 0.22 NA fiber and are designed for bilateral stimulation [optogenetics](#) applications where one light source is used to illuminate two fiber optic implants. They have SMA905 or FC/PC connectors on one side, and Ø1.25 mm or Ø2.5 mm ceramic ferrules on the other side, for connection to our [fiber optic cannulae](#). The fiber is jacketed in black Ø900 µm Hytrel[®] tubing to minimize light leakage from the fiber and with white or red heat-shrink wrap to indicate different ports. Thorlabs provides an individual data sheet for each coupler that contains measured test data verifying performance. A sample data sheet for these Ø200 µm core multimode couplers can be viewed [here](#).

Item #	Info	Wavelength Range	Coupling Ratio ^{a,b}	Insertion Loss ^{a,b}	Transmission ^a	Directivity ^a	Max Power Level ^c	Fiber ^d	Input Connector	Output Termination
TM200FL1B	i	400 - 2200 nm (Low OH)	50:50 ± 5.0%	≤4.1 dB / ≤4.1 dB	≥38.9% / ≥38.9%	≥40 dB	5 W (with Connectors)	Custom 0.22 NA Multimode Fiber	FC/PC	Ø1.25 mm Ceramic Ferrule
TM200SL1B	i								SMA905	
TM200FS1B	i								FC/PC	Ø2.5 mm Ceramic Ferrule
TM200SS1B	i								SMA905	

a. Specified at 650 nm and room temperature without connectors through the input port. The coupler can be used across its wavelength range, but performance may vary.

b. Please see the [1x2 Coupler Tutorial](#) tab for more information on these terms.

c. Specifies the total maximum power allowed through the component when mated using the input and output terminations.

d. For optimal performance, use with [patch cables](#) and [cannulae](#) that incorporate FG200LEA fiber.

Based on your currency / country selection, your order will ship from Newton, New Jersey

+1	Qty	Docs	Part Number - Universal	Price	Available
+	<input type="text"/>	d	TM200FL1B 1x2 MM Fiber Optic Coupler, Low OH, Ø200 µm Core, 0.22 NA, 50:50 Split, FC/PC to Ø1.25 mm Ceramic Ferrules	\$252.35	Today
+	<input type="text"/>	d	TM200SL1B 1x2 MM Fiber Optic Coupler, Low OH, Ø200 µm Core, 0.22 NA, 50:50 Split, SMA905 to Ø1.25 mm Ceramic Ferrules	\$272.95	Today
+	<input type="text"/>	d	TM200FS1B 1x2 MM Fiber Optic Coupler, Low OH, Ø200 µm Core, 0.22 NA, 50:50 Split, FC/PC to Ø2.5 mm Ceramic Ferrules	\$252.35	Today
+	<input type="text"/>	d	TM200SS1B 1x2 MM Fiber Optic Coupler, Low OH, Ø200 µm Core, 0.22 NA, 50:50 Split, SMA905 to Ø2.5 mm Ceramic Ferrules	\$272.95	Today

Add To Cart

Ø200 µm Core, 0.39 NA 2x2 Multimode Couplers



FCMH2-SMAF

- ▶ 2x2 Couplers with Ø200 µm, 0.39 NA Fiber
- ▶ SMA905 or FC/PC Connectors on Input Ports
- ▶ Ø1.25 mm or Ø2.5 mm Ceramic Ferrules on Output Ports
- ▶ Operating Temperature: -40 to 85 °C; Storage Temperature: -50 to 85 °C
- ▶ Coupler Dimensions: 2.36" x Ø0.16" (60 mm x Ø4 mm)

These 2x2 couplers incorporate FT200UMT Ø200 µm, 0.39 NA multimode fiber. They are designed for bilateral stimulation [optogenetics](#) applications where one light source is used to illuminate two fiber optic implants or simultaneous stimulation using two light sources. When used in a 1x2 configuration, a [fiber optic light trap](#) (only available for FC/PC connectors) can be placed on the other input port to minimize light leakage.

[Zoom](#)

The input ports feature SMA905 or FC/PC connectors, while the output ports feature Ø1.25 mm or Ø2.5 mm ceramic ferrules for connection to our [fiber optic cannulae](#).

The fiber is jacketed in Ø1/16" (Ø1.6 mm) heat-shrink tubing for protection and to block any light that may leak from the fiber. Each port is labeled with a number on white shrink wrap for easy identification.

Item # ^a	Wavelength Range ^b	Coupling Ratio	Insertion Loss	Transmission ^c	Directivity	Max Power Level	Fiber	Input Termination	Output Termination
FCMH2-FCL	400 - 900 nm (High OH)	50:50 ± 3.5% (Click for Plot)	≤5.5 dB at 455 nm (Click for Plot)	40% (Typ.) from 400 - 900 nm 28% (Min) at 455 nm (Click for Plot)	≥40 dB	300 mW (CW)	FT200UMT	FC/PC	Ø1.25 mm Ceramic Ferrule
FCMH2-FCF								FC/PC	Ø2.5 mm Ceramic Ferrule
FCMH2-SMAF								SMA905	

a. All specifications are measured without connectors during the manufacturing process.

b. All specifications listed here are guaranteed within the 400 - 900 nm operating wavelength range. However, the couplers perform well outside of this range as seen in the graphs in the table. Click [here](#) for raw data from these graphs.

c. Transmission is specified from any port on one side of the coupler to either port on the other side of the coupler. This specification accounts for the inherent 50% power splitting within the coupler.

Based on your currency / country selection, your order will ship from Newton, New Jersey

+1	Qty	Docs	Part Number - Universal	Price	Available
	<input type="text"/>	FCMH2-FCL	2x2 MM Coupler, 50:50 Split, Ø200 µm Core, 0.39 NA, FC/PC to Ø1.25 mm Ceramic Ferrules	\$557.87	Today
	<input type="text"/>	FCMH2-FCF	2x2 MM Coupler, 50:50 Split, Ø200 µm Core, 0.39 NA, FC/PC to Ø2.5 mm Ceramic Ferrules	\$557.87	Today
	<input type="text"/>	FCMH2-SMAF	2x2 MM Coupler, 50:50 Split, Ø200 µm Core, 0.39 NA, SMA905 to Ø2.5 mm Ceramic Ferrules	\$557.87	Today

Add To Cart