

M340L4 - April 29, 2022

Item # M340L4 was discontinued on April 29, 2022. For informational purposes, this is a copy of the website content at that time and is valid only for the stated product.

MOUNTED LEDs

- UV, Visible, IR, and Mid-IR Models Available
- Optimized Heat Management Results in Stable Output
- Internal SM1 (1.035"-40) Threading
- Collimation Adapters Available Separately



M405LP1
 405 nm,
 1200 mW Minimum
 Output Power



M505L4
 505 nm,
 400 mW Minimum
 Output Power



Mounted LED used as a
 Light Source for a DIY
 Cerna® Microscope

OVERVIEW

Mounted LED Features

- Wavelengths Ranging from 265 nm to 4300 nm (See LED Quick Links Table to the Right)
- White, Broadband, and Dual-Peak LEDs Also Available
- Integrated Memory Stores LED Operating Parameters
- Thermal Properties Optimized for Stable Output Power
- Microscope- and SM-Thread-Compatible Collimation Adapters Available
- 4-Pin Female Mating Connector for Custom Power Supplies can be Purchased Separately

Each Thorlabs uncollimated, mounted LED consists of a single LED mounted to the end of a heat sink with 6 mm deep, SM1 (1.035"-40) internal threads. LEDs with Ø1.20" heat sinks have the same outer diameter as an SM1 Lens Tube, allowing them to fit inside a 30 mm Cage System. A selection of our LEDs are mounted to larger heat sinks, as they generate more heat during operation. These heat sinks are enclosed in Ø57.0 mm vented plastic housings and include four 4-40 tapped holes on the front for integration



Click to Enlarge
 The MWWHL4 LED and COP1-A microscope collimation adapter used as a trans-illumination source for an Olympus microscope.



Click to Enlarge

Item #	Qty	Description
Metric Product List		
M385LP1	1	385 nm, 1650 mW (Min) Mounted LED, 1700 mA

LED Quick Links

Mounted LEDs

Deep UV (265 - 340 nm)

UV (365 - 405 nm)

Cold Visible (420 - 565 nm)

Warm Visible (590 - 730 nm)

IR (780 - 1650 nm)

Mid-IR (3400 - 4300 nm)

Purple (455 nm / 640 nm)

White (400 - 700 nm)

Broadband Mounted LEDs

LED Collimation^a

Adjustable Collimation Adapters

Microscope Collimation Adapters

LED Mating Connector

LED Drivers

- We offer suggestions for how to collimate most of our LEDs. Click on the info icons () below for details.

Webpage Features

with 30 mm cage systems.

Every LED features an EEPROM chip which stores information about the LED (e.g., current limit, wavelength, forward voltage). When controlled by a Thorlabs DC2200, DC4100, or DC4104 LED driver, the data can be used to implement smart safety features.

These mounted LEDs possess good thermal stability properties, eliminating the issue of degradation of optical output power due to increased LED temperature. For more details, please see the *Stability* tab.

Please note that mounted LEDs are not intended for use in household illumination applications.

LED Collimation

Our adjustable collimation adapters can translate a Ø1" (Ø25 mm) or Ø2" (Ø50 mm) lens by up to 11 mm or 20 mm, respectively. Each adjustable collimation adapter includes an internal SM2 (2.035"-40) thread adapter so that the LEDs can be easily integrated with Thorlabs' SM2-threaded components, such as our Ø2" lens tubes. These adapters are offered in versions with and without an AR-coated aspheric condenser lens.

In addition, microscope collimation adapters are available that incorporate an AR-coated aspheric lens. These adapters mate to the epi-illumination ports on select Leica DMI, Nikon Eclipse Ti, Olympus IX/BX, or Zeiss Axioskop microscopes. Thorlabs also offers mounted LEDs with pre-attached microscope collimation adapters.

We offer suggestions for collimating most LEDs. Click on the info icon (i) for each LED below for details.

Driver Options

Thorlabs offers four drivers compatible with most or all of these LEDs: LEDD1B, DC2200, DC4100, and DC4104 (the latter two require the DC4100-HUB). See the tables below for driver compatibility info. The LEDD1B is capable of providing LED modulation frequencies up to 5 kHz, while DC4100 and DC4104 can modulate the LED at a rate up to 100 kHz. The DC2200 can provide modulation at up to 250 kHz if driven by an external source. In addition, the DC2200, DC4100, and DC4104 drivers are capable of reading the current limit from the EEPROM chip of the connected LED and automatically adjusting the maximum current setting to protect the LED.

Multi-LED Source

A customizable multi-LED source may be constructed using our mounted LEDs and other Thorlabs items. This source may be configured for integration with Thorlabs' versatile SM1 Lens Tube Systems and 30 mm Cage Systems. Please see the *Multi-LED Source* tab for a detailed item list and instructions.

Thorlabs also offers integrated, user-configurable 4-Wavelength High-Power LED Sources.



CP33/M	1	SM1-Threaded 30 mm Cage Plate, 0.35" Thick, 2 Retaining Rings, M4 Tap
TR150/M	1	Ø12.7 mm Optical Post, SS, M4 Setscrew, M6 Tap, L = 150 mm
ER3-P4	1	Cage Assembly Rod, 3" Long, Ø6 mm, 4 Pack
Add To Cart Export Forward		

[APPLIST]
[APPLIST]

High-Power LED Inserted into CP33 Cage Plate and Mounted with Ø6 mm Cage Rods



Click to Enlarge
MWWHL4 LED
Mounted in an SM1RC
Slip Ring

 Clicking this icon opens a window that contains specifications, mechanical drawings, and information about driver and collimator compatibility.
 Clicking this icon allows you to download our standard support documentation.



A mounted LED requires an LED driver to run; a collimation adapter (optional) collimates the diverging beam emitted by the LED. See the tables below to determine the appropriate LED driver. To determine the needed collimation adapter for a given LED, see the info icons (i) below.

RELATIVE POWER

Relative Power

The actual spectral output and total output power of any given LED will vary due to variations in the manufacturing process and operating parameters, such as temperature and current. Both a typical and minimum output power are specified to help you select an LED that suits your needs. Each mounted LED will provide at least the minimum specified output power at the maximum current. In order to provide a point of comparison for the relative powers of LEDs with different nominal wavelengths, the spectra in the plots below have been scaled to the minimum output power for each LED. This data is representative, not absolute. Excel files with normalized and scaled spectra for each set of the mounted LEDs can be downloaded by clicking below the graphs.

Deep UV LED Spectra Scaled to Min Power

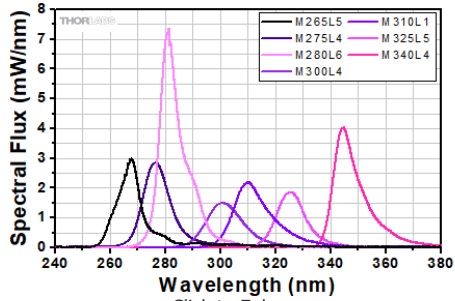

Click to Enlarge
Click Here for Data

UV LED Spectra Scaled to Min Power

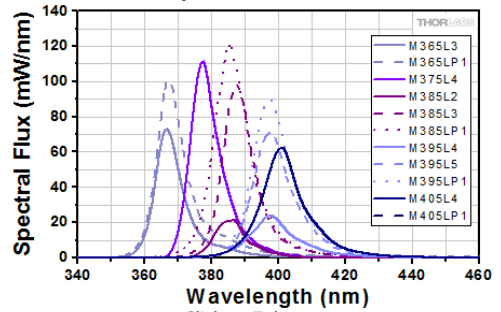

Click to Enlarge
Click Here for Data

Visible LED Spectra Scaled to Min Power

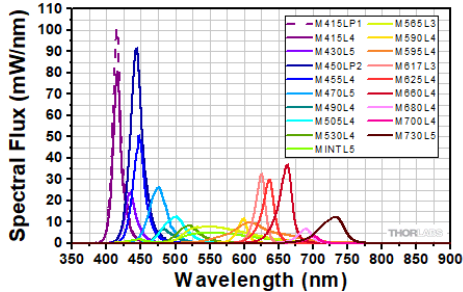

Click to Enlarge
Click Here for Data

IR LED Spectra Scaled to Min Power

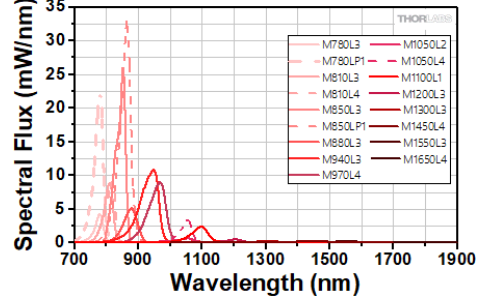

Click for Details
Click Here for Data

Mid-IR LED Spectrum Scaled to Min Power

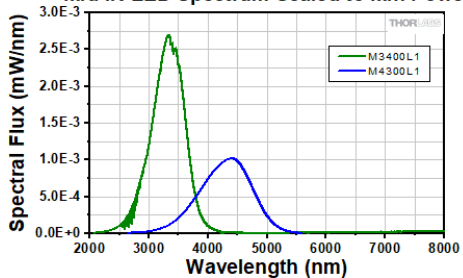

Click to Enlarge
Click Here for Data

The spectrum shown for M4300L1 is ideal. Please see the Spec Sheet for more information.

Purple LED Spectrum Scaled to Min Power

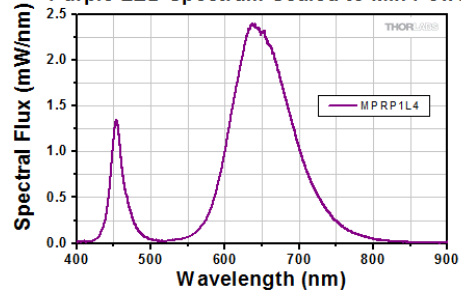

Click to Enlarge
Click Here for Data

White LED Spectra Scaled to Min Power

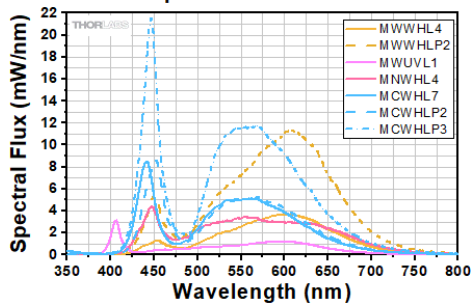

Click to Enlarge
Click Here for Data

Broadband LED Spectra Scaled to Min Power

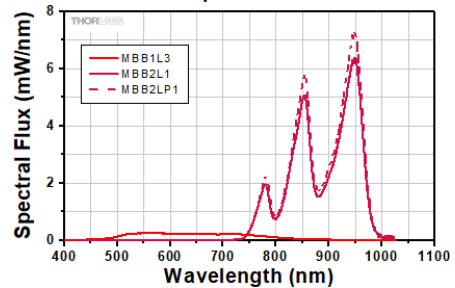

Click to Enlarge
Click Here for Data

STABILITY

LED Lifetime and Long-Term Power Stability

One characteristic of LEDs is that they naturally exhibit power degradation with time. Often this power degradation is slow, but there are also instances where large, rapid drops in power, or even complete LED failure, occur. LED lifetimes are defined as the time it takes a specified percentage of a type of LED to fall below some power level. The parameters for the lifetime measurement can be written using the notation B_{XX}/L_{YY} , where XX is the percentage of that type of LED that will provide less than YY percent of the specified output power after the lifetime has elapsed. Thorlabs defines the lifetime of our LEDs as B_{50}/L_{50} , meaning that 50% of the LEDs with a given item # will fall below 50% of the initial optical power at the end of the specified lifetime. For example, if a batch of 100 LEDs is rated for 150 mW of output power, 50 of these LEDs can be

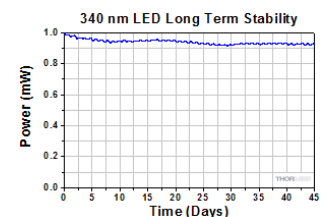

Click to Enlarge
Our 340 nm mounted LED has a typical

expected to produce an output power of ≤ 75 mW after the specified LED lifetime has elapsed.

lifetime of $>3,000$ hours. In this case, the unit under test continued to provide more than 90% of its initial power after 45 days.

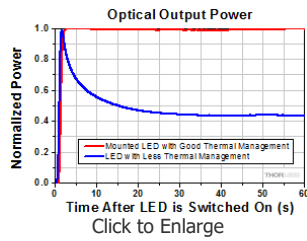

The sample plot to the right shows example data from long-term stability testing over a 45 day period for a 340 nm mounted LED, which had a lifetime of $>3,000$ hours (~ 125 days). The small power drop experienced by the LED after it is turned on is typical behavior during the first few minutes of operation. It corresponds to the period of time required for the LED to warm up to the point where it is thermally stable. Please note that this graph represents the performance of a single LED; the performance of individual LEDs will vary within the stated specifications.

Optimized Thermal Management

The thermal dissipation performance of these mounted LEDs has been optimized for stable power output. The heat sink is directly mounted to the LED mount so as to provide optimal thermal contact. By doing so, the degradation of optical output power that can be attributed to increased LED junction temperature is minimized (see the graph to the left).

COLLIMATION

Obtaining a Well-Collimated Beam

After installing the chosen collimation package on a mounted LED, the distance between the lens and the LED may need to be adjusted to ensure that the LED is properly collimated. A well-collimated beam has minimal divergence and will not converge at any point in the beam path (see images below for comparison). Be advised that, due to the high emitter surface area of the LED, the output beam cannot be perfectly collimated. Divergence data for select LEDs is provided in the below table as a reference; see the info icons () below for the recommended collimating optic for each LED.

1. Power on the LED and check to see if it is properly collimated. It is easiest to check that the beam is collimated by noting the changes in the beam diameter over a range of about 1" to 2 feet away; change the distance of the lens from the LED and check again. Do this until the least divergent, non-converging, homogenous beam is obtained. The beam should be somewhat circular, may have a slightly polygonal shape, and should not be a clear image of the LED itself.
2. If you see an image of the LED, this means that the lens is not close enough to the LED. Move the lens closer to the LED until the image blurs and becomes homogenous – this is the point of collimation. Note: If the lens needs to be closer to the LED when using the DIY collimation assembly, use one retaining ring to secure the lens against the internal lip of the SM1V05.



Click to Enlarge
Image of the LED



Click to Enlarge
Uncollimated Beam



Click to Enlarge
Collimated Beam

3. Once the proper collimation position of the lens has been found, lock the position of the lens in place.

The table below provides examples of how the half viewing angle changes for select LEDs with the addition of a $\varnothing 1"$ aspheric condenser lens.

Item #	Color	Nominal Wavelength ^a	Optimum Lens to Emitter Distance ^b	Half Viewing Angle ^c		
				+1 mm Out of Focus ^d	at Optimum Focusing Distance	-1 mm Out of Focus ^d
M385L2	UV	385 nm	12.8 mm	2.68°	1.33°	3.06°
M850L3	IR	850 nm	13.8 mm	3.29°	3.10°	3.93°
M940L3	IR	940 nm	13.9 mm	3.42°	2.46°	3.70°

- a. The specifications listed in the table above are nominal values specified by the LED manufacturer.
- b. Optimum distance between the respective mounted LED and the ACL2520U lens used to collimate the beam.
- c. Power loss to $1/e^2$ (13.5%).
- d. ± 1 mm out of focus from Optimum Distance between the respective mounted LED and the ACL2520U lens used to collimate the beam.

The divergence data was calculated using Zemax.

PIN DIAGRAM

Pin Connection - Male

The diagram to the right shows the male connector of the mounted LED assembly. It is a standard M8 x 1 sensor circular connector. Pins 1 and 2 are the connection to the LED. Pin 3 and 4 are used for the internal EEPROM in these LEDs. If using an LED driver that was not purchased from Thorlabs, be careful that the appropriate connections are made to Pin 1 and Pin 2 and that you do not attempt to drive the LED through the EEPROM pins.



Pin	Specification	Color
1	LED Anode	Brown
2	LED Cathode	White
3	EEPROM GND	Black
4	EEPROM IO	Blue

MULTI-LED SOURCE

Creating a Custom Multi-LED Source for Microscope Illumination

Thorlabs offers the items necessary to create your own custom multi-LED light source using two or three of the mounted LEDs offered below. As configured in the following example, the light source is intended to be used with the illumination port of a microscope. However, it may be integrated with other applications using Thorlabs' versatile SM1 Lens Tube and 30 mm Cage Systems. Thorlabs also offers integrated, user-configurable 4-Wavelength LED Sources.

Design & Construction

First, light will be collimated by lenses mounted in lens tubes. Dichroic mirrors mounted in kinematic cage cubes then combine the output from the multiple LEDs. The mounted LEDs may be driven by LEDD1B Compact T-Cube LED Drivers (power supplies are sold separately). The LEDD1B LED Drivers allow each LED's output to be independently modulated and can provide up to 1200 mA of current. Please take care not to drive the LED sources above their max current ratings.

When designing your custom source, select mounted LEDs from below along with dichroic mirror(s) that have cutoff wavelength(s) between the LED wavelengths. The appropriate dichroic mirror(s) will reflect light from side-mounted LEDs and transmit light along the optical axis. Please note that most of these dichroic mirrors are "longpass" filters, meaning they transmit the longer wavelengths and reflect the shorter wavelengths. To superimpose light from three or more LEDs, add each in series (as shown below), starting from the back with longer wavelength LEDs when using longpass filters. Shortpass filters may also be used if the longer wavelength is reflected and the shorter wavelength is transmitted. Sample combinations of compatible dichroic mirrors and LEDs are offered in the three tables below.

It is also necessary to select an aspheric condenser lens for each source with AR coatings appropriate for the source. Before assembling the light source, collimate the light from each mounted LED as detailed in the *Collimation* tab. For mounting the aspheric lenses in the SM1V05 Lens Tubes using the included SM1RR retaining rings, we recommend the SPW801 Adjustable Spanner Wrench. A properly collimated LED source should have a resultant beam that is approximately homogenous and not highly divergent at a distance of approximately 2 feet (60 cm). An example of a well-collimated beam is shown on the *Collimation* tab.

After each LED source is collimated, thread the SM1V05 Lens Tubes at the end of each collimated LED assembly into their respective C4W Cage Cube ports using SM1T2 Lens Tube Couplers. Install each dichroic filter in an FFM1 Dichroic Filter Holder, and mount each filter holder onto a B4C Kinematic Cage Cube Platform. Each platform is then installed in the C4W Cage Cubes by partially threading the included screws into the bottom of the cube, and then inserting and rotating the B4C platform into place. Align the platform to the desired position and then firmly tighten the screws. To connect multiple cage cubes and the microscope adapter, use the remaining SM1T2 lens tube couplers along with an SM1L05 0.5" Lens Tube between adjacent cage cubes. Finally, adjust the rotation, tip, and tilt of each B4C platform to align the reflected and transmitted beams so they overlap as closely as possible.

If desired, a multi-LED source may be constructed that employs more than three LEDs. The limiting factors for the number of LEDs that can be practically used are the collimation of the light and the dichroic mirror efficiency over the specified range. Heavier multi-LED sources may be supported with our Ø1" or Ø1.5" Posts.



[Click to Enlarge Multi-LED Source Coupled to Microscope Illumination Port](#)



Click to Enlarge

Three-LED Source Using Components Mounted LEDs and Dichroic Mirrors Detailed in Example Configuration 1



Click to Enlarge
Beam Profile of Source with 3 Mounted LEDs



Click to Enlarge
Two-LED source. This is the same as Example 1, but with the blue LED removed.

Parts List					
#	Product Description		Item #	2 LEDs	3 LEDs
				Item Qty.	
1	Microscope Illumination Port Adapter:	Olympus IX or BX	SM1A14	1	1
		Leica DMI	SM1A21		
		Zeiss Axioskop	SM1A23 ^a		
		Nikon Eclipse Ti	SM1A26		
2	Mounted LED ^b		-	2	3
-	T-Cube LED Driver, 1200 mA Max Drive Current		LEDD1B ^c	2	3
-	15 V Power Supply for K- and T-Cube		KPS201 ^c	2	3
3	4-Way Mounting 30 mm Cage Cube		C4W	1	2
4	Kinematic Cage Cube Platform for C4W/C6W		B4C	1	2
5	30 mm Cage-Compatible Dichroic Filter Mount		FFM1	1	2
6	Dichroic Filter(s) ^d		-	1	2
7	Externally SM1-Threaded End Cap		SM1CP2	1	2
8	SM1 (1.035"-40) Coupler, External Threads, 0.5" Long		SM1T2	3	5
9	Ø1" SM1 Lens Tube, 1/2" Long External Threads		SM1V05	2	3
-	Aspheric Condenser Lens	AR-Coated 350 - 700 nm	ACL2520U-A ^{c,e}	2	3
		AR-Coated 650 - 1050 nm	ACL2520U-B ^{c,e}		
10	SM1 Lens Tube, 0.3" Thread Depth		SM1L03	2	4
-	Blank Cover Plate with Rubber O-Ring for C4W/C6W		B1C ^c	1	2

a. The SM1A23 Zeiss Axioskop Microscope Adapter is shown.

b. Mounted LEDs are available below.

c. Item not pictured.

d. Please see the following tables for suggested compatible LED and dichroic filter combinations, or create your own by taking into account the transmission and reflection wavelength ranges of our Dichroic Filters.



e. Lenses are mounted in the SM1V05 Lens Tube in front of each LED. For each lens, select an AR coating corresponding to the emission wavelength of the LED source.

Example Configuration 1		Example Configuration 2		Example Configuration 3	
Mounted LEDs		Mounted LEDs		Mounted LEDs	
#	Item #	#	Item #	#	Item #
2a	M625L4	2a	M625L4	2a	M1050L2
2b	M530L4	2b	M455L4	2b	MCWHL7

2c	M455L4	2c	M1050L2	Dichroic Filter(s)	
Dichroic Filter(s)		Dichroic Filter(s)		#	Item #
#	Item #	#	Item #	6a	DMLP900R
6a	DMLP605R	6a	DMLP505R		
6b	DMLP505R	6b	DMSP805R		

RAY DATA

Ray data for Zemax is available for some of the bare LEDs incorporated into these high-powered light sources. This data is provided in a zipped folder that can be downloaded by clicking on the red document icons () next to the part numbers in the pricing tables below. Every zipped folder contains an information file and one or more ray files for use with Zemax:

Item #	Information File	Available Ray Files	File Size	Click to Download
M385L2	M385_Info.pdf	1 Million Rays and 5 Million Rays	148 MB	
M850L3^a	SFH4715S_100413_info.pdf	100,000 Rays, 500,000 Rays, and 5 Million Rays	140 MB	
M940L3^a	SFH_4725S_110413_info.pdf	100,000 Rays, 500,000 Rays, and 5 Million Rays	140 MB	

a. A radiometric color spectrum, bare LED CAD file, and sample Zemax file are also available for these LEDs.

- **Information File:** This document contains a summary of the types of data files included in the zipped folder and some basic information about their use. It includes a table listing each document type and the corresponding filenames.
- **Ray Files:** These are binary files containing ray data for use with Zemax.

For the LEDs marked with an superscript "a" in the table to the right, the following additional pieces of information are also included in the zipped folder:

- **Radiometric Color Spectrum:** This .spc file is also intended for use with Zemax.
- **CAD Files:** A file indicating the geometry of the bare LED. For the dimensions of the high-power mounted LEDs that include the package, please see the support drawings provided by Thorlabs.
- **Sample Zemax File:** A sample file containing the recommended settings and placement of the ray files and bare LED CAD model when used with Zemax.

The table to the right summarizes the ray files available for each LED and any other supporting documentation provided.

USE WITH CERNA

Using Mounted LEDs in Cerna[®] Microscope Systems

Mounted LEDs, which can have either narrowband or broadband spectra, are useful for a range of applications within Thorlabs' Cerna microscopy platform:

- Fluorescence Microscopy
- Brightfield Microscopy
- Near Infrared/Infrared (NIR/IR) Microscopy

Components for Cerna [®] Compatibility
Epi-Illumination
WFA2001 Epi-Illuminator Module
Trans-Illumination
Illumination Kits

If you are interested in using a mounted LED with a Cerna modular microscopy system, the mounted LED can be attached by way of the single-cube epi-illuminator module (Item # WFA2001), which contains AR-coated optics optimized for the 350 - 700 nm wavelength range. The mounted LED and epi-illuminator module are connected together by an externally threaded coupler (Item # SM1T10, provided with the WFA2001), which includes two knurled locking rings (Item # SM1NT, also provided with the WFA2001) that are tightened by hand. The mounted LED is then powered by a driver, sold separately. Please see the *LED Drivers* tab to identify the appropriate driver for your mounted LED. If you wish to connect multiple mounted LEDs to the epi-illuminator module, contact Technical Support.

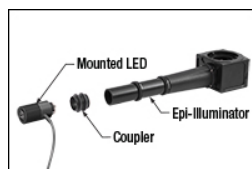

Enlarge

An exploded view of the mounted LED and its connection with the WFA2001

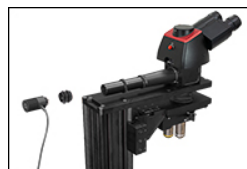

Enlarge

Attaching the mounted LED is possible before or after connecting the epi-

epi-illuminator module.



Click to

Enlarge

The mounted LED and epi-illuminator module attached to the Cerna microscope.

illuminator module to the microscope.

Please see the *Overview* tab to choose the appropriate color spectrum of mounted LED for your imaging needs. Again, note that the epi-illuminator module is optimized for 350 - 700 nm wavelength illumination sources.

Certain mounted LEDs are also compatible with our illumination kits for trans-illumination. Please contact Technical Support if you wish to use an LED not currently offered as a component of these kits, as the collimating optics are optimized for certain beam characteristics.

LED DRIVERS

Compatible Drivers	UPLED ^a	LEDD1B	DC2200 ^a	DC4100 ^{a,b,c}	DC4104 ^{a,b,c}
Click Photos to Enlarge					
LED Driver Current Output (Max)	1.2 A	1.2 A	LED1 Terminal: 10.0 A LED2 Terminal: 2.0 A ^d	1.0 A per Channel	1.0 A per Channel
LED Driver Forward Voltage (Max)	8 V	12 V	50 V	5 V	5 V
Modulation Frequency Using External Input (Max)	-	5 kHz	250 kHz ^{e,f}	100 kHz ^f (Simultaneous Across all Channels)	100 kHz ^f (Independently Controlled Channels)
External Control Interface(s)	USB 2.0	Analog (BNC)	USB 2.0 and Analog (BNC)	USB 2.0 and Analog (BNC)	USB 2.0 and Analog (8-Pin)
Main Driver Features	USB-Controlled	Very Compact Footprint 60 mm x 73 mm x 104 mm (W x H x D)	Touchscreen Interface with Internal and External Options for Pulsed and Modulated LED Operation	4 Channels ^c	4 Channels ^c
EEPROM Compatible: Reads Out LED Data for LED Settings	✓	-	✓	✓	✓
LCD Display	-	-	✓	✓	✓

a. Automatically limits to LED's max current via EEPROM readout.

b. The DC4100 and DC4104 can power and control up to four LEDs simultaneously when used with the DC4100-HUB. The LEDs on this page all require the DC4100-HUB when used with the DC4100 or DC4104.

c. These LED drivers have a maximum forward voltage rating of 5 V and can provide a maximum current of 1000 mA. As a result, they cannot be used to drive LEDs which have forward voltage ratings greater than 5 V. LEDs with maximum current ratings higher than 1.0 A can be driven using this driver, but will not reach full power.

d. The mounted LEDs sold below are compatible with the LED2 Terminal.

e. Small Signal Bandwidth: Modulation not exceeding 20% of full scale current. The driver accepts other waveforms, but the maximum frequency will be reduced.

f. Several of these LEDs produce light by stimulating emission from phosphor, which limits their modulation frequencies. The M565L3, M595L4, and all purple or white LEDs may not turn off completely when modulated above 10 kHz at duty cycles below 50%. The MBB1L3 LED may not turn off completely when modulated at frequencies above 1 kHz with a duty cycle of 50%. When the MBB1L3 is modulated at frequencies above 1 kHz, the duty cycle may be reduced; for example, 10 kHz modulation is attainable with a duty cycle of 5%.

LED SELECTION GUIDE

Light Emitting Diode (LED) Selection Guide										
(Click Representative Photo to Enlarge; Not to Scale)										
Wavelength	Unmounted LEDs	Pigtailed LEDs	LEDs in SMT Packages	PCB-Mounted LEDs	Heatsink-Mounted LEDs	Collimated LEDs for Microscopy ^a	Fiber-Coupled LEDs ^b	High-Power LEDs for Microscopy	Multi-Wavelength LED Source Options ^c	LED Arrays
Single Color LEDs										
250 nm	LED250J (1 mW Min)	-	-	-	-	-	-	-	-	-
255 nm	LED255W (0.4 mW)	-	-	-	-	-	-	-	-	-
	LED255J (1 mW Min)									
260 nm	LED260W (1 mW)	-	-	-	-	-	-	-	-	-
	LED260J (1 mW Min)									
265 nm	-	-	-	M265D4 (38.4 mW Min) ^d	M265L5 (38.4 mW Min) ^d	-	-	-	-	-
275 nm	LED275W (1.6 mW)	-	-	M275D2 (45 mW Min)	M275L4 (45 mW Min)	-	-	-	-	-
	LED275J (1 mW Min)			M275D3 (47.3 mW Min) ^d						
280 nm	LED280W (2.3 mW)	-	-	-	M280L6 (78 mW Min) ^d	-	M280F5 (0.5 mW Min) ^d	-	-	-
285 nm	LED285W (1.6 mW)	-	-	M285D3 (50 mW Min)	-	-	-	-	-	-
	LED285J (1.3 mW)									
290 nm	LED290W (1.6 mW)	-	-	-	-	-	-	-	-	-
295 nm	LED295W (1.2 mW)	-	-	-	-	-	-	-	-	-
300 nm	LED300W (1.2 mW)	-	-	M300D3 (26 mW Min)	M300L4 (26 mW Min)	-	M300F2 (320 μW)	-	-	-
308 nm	-	-	-	M310D1 (38.5 mW Min) ^d	M310L1 (38.5 mW Min) ^d	-	M310F1 (0.51 mW) ^d	-	-	-
310 nm	LED310W (1.5 mW)	-	-	-	-	-	-	-	-	-
325 nm	LED325W2 (1.7 mW)	-	-	M325D3 (25 mW Min)	M325L5 (25 mW Min)	-	M325F4 (350 μW)	-	-	-
340 nm	LED340W (1.7 mW)	-	-	M340D4 (45.5 mW Min) ^d	M340L4 (53 mW Min)	-	M340F4 (0.75 mW) ^d	-	-	-
	LED341W (0.33 mW)									

470 nm	LED470L (170 mW)	(18 mW Min) EP470S10 (100 mW Min)	-	M470D4 (809 mW Min) ^d	M470L5 (809 mW Min) ^d	M470L5-Cx (402 mW) ^e	M470F3 (21.8 mW)	SOLIS-470C (3.0 W) ^f	Wavelength Source (250 mW)	LIU470A (253 mW)
475 nm	-	-	-	-	-	-	-	-	Chrolis (630 mW)	-
490 nm	LED490L (3 mW)	-	-	M490D3 (205 mW Min)	M490L4 (205 mW Min)	-	M490F3 (3.1 mW)	-	Chrolis (120 mW) 4- Wavelength Source (50 mW)	-
505 nm	LED505L (4 mW)	-	-	M505D3 (400 mW Min)	M505L4 (400 mW Min)	M505L3-Cx (150 mW) ^e M505L4-Cx (170 mW) ^e	M505F3 (11.7 mW)	SOLIS-505C (1.0 W) ^f	4- Wavelength Source (170 mW)	-
525 nm	LED525E (2.6 mW Max) LED525L (4 mW) LED528EHP (7 mW)	-	-	-	-	-	-	SOLIS-525C (2.4 W) ^f	Chrolis (180 mW)	LIU525A (111 mW)
530 nm	-	-	-	M530D3 (370 mW Min)	M530L4 (370 mW Min)	M530L4-Cx (160 mW) ^e	M530F2 (9.6 mW)	-	4- Wavelength Source (100 mW)	-
545 nm	LED545L (2.4 mW CW, 8.7 mW Pulsed)	-	-	-	-	-	-	-	-	-
554 nm	-	-	-	MINTD3 (650 mW Min)	MINTL5 (650 mW Min)	-	MINTF4 (28 mW)	-	-	-
562 nm	LED560L (0.15 mW) ^d	-	-	-	-	-	-	-	-	-
565 nm	-	-	-	M565D2 (880 mW Min)	M565L3 (880 mW Min)	-	M565F3 (13.5 mW)	SOLIS-565C (3.2 W) ^f	Chrolis (350 mW) 4- Wavelength Source (106 mW)	-
570 nm	LED570L (0.3 mW)	-	-	-	-	-	-	-	-	-
590 nm	LED590L (2 mW) LED591E (2 mW)	EP590S04 (3.5 mW Min) EP590S10 (18 mW Min)	-	M590D3 (230 mW Min)	M590L4 (230 mW Min)	M590L3-Cx (60 mW) ^e M590L4-Cx (100 mW) ^e	M590F3 (4.6 mW)	SOLIS-590C (350 mW) ^f	Chrolis (140 mW) 4- Wavelength Source (65 mW)	LIU590A (109 mW)
595 nm	-	-	-	M595D3 (820 mW Min)	M595L4 (820 mW Min)	-	M595F2 (11.5 mW)	SOLIS-595C (700 mW) ^f	-	-
Wavelength	Unmounted LEDs	Pigttailed LEDs	LEDs in SMT Packages	PCB-Mounted LEDs	Heatsink-Mounted LEDs	Collimated LEDs for Microscopy^a	Fiber-Coupled LEDs^b	High-Power LEDs for Microsocopy	Multi-Wavelength LED Source Options^c	LED Arrays
Single Color LEDs										
600 nm	LED600L (3 mW)	-	-	-	-	-	-	-	-	-
610 nm	LED610L (8 mW)	-	-	-	-	-	-	-	-	-
617 nm	-	-	-	M617D2 (600 mW Min)	M617L3	M617L3-Cx (230 mW) ^e	M617F2	SOLIS-617C	4- Wavelength	-

				M617D3 (660 mW Min)	(600 mW Min)	M617L4-Cx (280 mW) ^e	(13.2 mW)	(1.5 mW) ^f	Source (210 mW)	
620 nm	-	-	-	-	-	-	-	SOLIS-620D (3.47 W) ^f	-	-
625 nm	LED625L (12 mW)	-	-	M625D3 (700 mW Min)	M625L4 (700 mW Min)	M625L3-Cx (270 mW) ^e	M625F1 (17.5 mW)	-	Chrolis (490 mW)	-
						M625L4-Cx (490 mW) ^e			4- Wavelength Source (240 mW)	
630 nm	LED630L (16 mW)	-	-	-	-	-	-	-	-	LIU630A (208 mW)
635 nm	LED631E (4 mW)	-	-	-	-	-	-	-	-	-
	LED635L (170 mW)									
639 nm	LED630E (7.2 mW)	-	-	-	-	-	-	-	-	-
645 nm	LED645L (16 mW)	-	-	-	-	-	-	-	-	-
660 nm	LED660L (13 mW)	-	-	M660D2 (940 mW Min)	M660L4 (940 mW Min)	M660L4-Cx (400 mW) ^e	M660FP1 (15.5 mW)	SOLIS-660C (2.0 W) ^f	4- Wavelength Source (210 mW)	-
670 nm	LED670L (12 mW)	-	-	-	-	-	-	-	-	-
680 nm	LED680L (8 mW)	-	-	M680D2 (180 mW Min)	M680L4 (180 mW Min)	-	M680F3 (2.7 mW)	-	-	-
700 nm	-	EP700S04 (5 mW Min)	-	M700D2 (80 mW Min)	M700L4 (80 mW Min)	-	M700F3 (1.7 mW)	-	-	-
		EP700S10 (30 mW Min)								
730 nm	-	-	-	M730D3 (540 mW Min)	M730L5 (540 mW Min)	-	-	-	-	-
740 nm	-	-	-	-	-	-	M740F2 (6.0 mW)	SOLIS-740C (2.0 W) ^f	-	-
750 nm	LED750L (18 mW)	-	-	-	-	-	-	-	-	-
760 nm	LED760L (24 mW)	-	-	-	-	-	-	-	-	-
770 nm	LED770L (22 mW)	-	-	-	-	-	-	-	-	-
780 nm	LED780E (18 mW)	-	-	M780D2 (200 mW Min)	M780L3 (200 mW Min)	M780L3-Cx (130 mW) ^e	M780F2 (7.5 mW)	-	Chrolis (40 mW)	LIU780A (315 mW)
	LED780L (22 mW)			M780D3 (800 mW Min)	M780LP1 (800 mW Min)					
800 nm	LED800L (20 mW)	-	-	-	-	-	-	-	-	-
810 nm	LED810L (22 mW)	EP810S04 (16 mW Min)	-	M810D2 (325 mW Min)	M810L3 (325 mW Min)	M810L3-Cx (210 mW) ^e	M810F2 (6.5 mW)	-	-	-
		EP810S10 (90 mW Min)		M810D3 (363 mW Min)	M810L4 (363 mW Min)					
830 nm	LED830L (22 mW)	-	-	-	-	-	-	-	-	-
840 nm	LED840L (22 mW)	-	-	-	-	-	-	-	-	-
850 nm	LED851L (13 mW)	-	-	M850D2 (900 mW Min)	M850L3 (900 mW Min)	M850L3-Cx (330 mW) ^e	M850F3 (8.6 mW Min) ^d	SOLIS-850C (2.7 W) ^f	-	LIU850A (322 mW)
				M850D3 (1400 mW)	M850LP1 (1400 mW Min)					















and 625 nm	and 0.19 mW)									
588 nm and 617 nm	LEDRY (0.09 mW and 0.19 mW)	-	-	-	-	-	-	-	-	-
467.5 nm, 525 nm, and 627.5 nm	LEDRGBE (5.8 mW, 6.2 mW, and 3.1 mW)	-	-	-	-	-	-	-	-	-
430 - 660 nm (White)	LEDWE-15 (13 mW)	-	-	-	-	-	-	-	-	-
	LEDW7E (15.0 mW)									
	LEDW25E (15.0 mW)									
6500 K (Cold White)	-	-	-	MCWHD5 (930 mW Min)	MCWHL7 (930 mW Min)	-	-	SOLIS-1D (5.8 W) ^f	-	-
				MCWHD6 (942 mW Min) ^d	MCWHLP2 (942 mW Min) ^d					
6200 K (Cold White)	-	-	-	-	-	-	MCWHF2 (27.0 mW)	-	-	-
5000 K (Cold White)	-	-	LEDSW50 (110 mW)	-	-	-	-	-	-	-
4600 - 9000 K (Cold White)	-	-	-	-	-	-	-	-	-	LIUCWHA (250 mW)
4000 K (Warm White)	-	-	LEDSW40 (115 mW)	-	-	-	MWWHF2 (23.1 mW)	-	-	-
3000 K (Warm White)	-	-	LEDSW30 (100 mW)	MWWHD4 (1713 mW Min) ^d	MWWHL4 (570 mW Min)	-	-	SOLIS-2C (3.2 W) ^f	-	-
					MWWHLP2 (1713 mW Min) ^d					
5700 K (Day Light White)	-	-	-	-	-	-	-	SOLIS-3C (3.5 W)	-	-
470 - 850 nm (Broadband)	-	-	-	MBB1D1 (70 mW Min)	MBB1L3 (70 mW Min)	-	MBB1F1 (1.2 mW)	-	-	-
770 nm, 860 nm, & 940 nm (Broadband)	-	-	-	MBB2D1 (740 mW Min) ^d	MBB2L1 (650 mW Min) ^d	-	-	-	-	-
					MBB2LP1 (740 mW Min) ^d					

- These Collimated LEDs are compatible with the standard and epi-illumination ports on the following microscopes: Olympus BX/IX (Item # Suffix: -C1), Leica DMI (Item # Suffix: -C2), Zeiss Axioskop (Item # Suffix: -C4), and Nikon Eclipse (Bayonet Mount, Item # Suffix: -C5).
- Typical power when used with MM Fiber with Ø400 µm core, 0.39 NA.
- Our Multi-Wavelength LED Sources are available with select combinations of the LEDs at these wavelengths.
- Measured at 25 °C
- Typical power for LEDs with the Leica DMI collimation package (Item # Suffix: -C2).
- Minimum power for the collimated output of these LEDs. The collimation lens is installed with each LED.
- Typical power for LEDs with the Olympus BX and IX collimation package (Item # Suffix: -C1).
- Typical power for LEDs with the Nikon Eclipse collimation package (Item # Suffix: -C5).
- Percentage of LED intensity that emits in the blue portion of the spectrum, from 400 nm to 525 nm.
- Typical power for LEDs with the Zeiss Axioskop collimation package (Item # Suffix: -C4).

Deep UV Mounted LEDs (265 - 340 nm)

Please note that our deep UV LEDs radiate intense UV light during operation. Precautions must be taken to prevent looking directly at the UV light, and UV light protective glasses must be worn to avoid eye damage. Exposure of the skin and other body parts to UV light should be avoided.

				LED Output			Max	Forward	Viewing Angle
--	--	--	--	------------	--	--	-----	---------	---------------

Item #	Info ^a	Nominal Wavelength ^b	Housing Type ^c	Power (Min / Typ.) ^{b,d}	Bandwidth (FWHM)	Irradiance ^e	Current (CW)	Voltage (Typ.)	(Full Angle at Half Max)	Recommended Driver
M265L5		265 nm		38.4 mW / 55.7 mW ^f	11 nm ^f	0.5 μW/mm ² d,f	440 mA ^f	6.9 V ^{d,f}	120° d,f	UPLED, DC2200, or LEDD1B
M275L4		275 nm		45 mW / 80 mW	11 nm	0.8 μW/mm ²	700 mA	7.3 V	118°	DC2200 or LEDD1B
M280L6		280 nm		78 mW ^f / 114 mW ^f	10 nm ^f	1 μW/mm ²	500 mA ^f	6.26 V ^f	114° f,g	
M300L4		300 nm		26 mW / 32 mW	20 nm	0.3 μW/mm ²	350 mA	8.0 V	130°	
M310L1		308 nm		38.5 mW / 56.5 mW ^f	30 nm ^f	0.76 μW/mm ² f	600 mA ^f	5 V ^f	120° f,g	
M325L5		325 nm		25 mW / 35 mW	12 nm	0.44 μW/mm ² (Max)	600 mA	5.2 V	120°	
M340L4		340 nm		53 mW / 60 mW	11 nm	2.22 μW/mm ²	700 mA	4.6 V	110°	DC2200, LEDD1B, DC4100 ^h , or DC4104 ^h

- Click on the blue info icon for complete specifications and LED spectrum.
- Due to variations in the manufacturing process and operating parameters such as temperature and current, the actual spectral output of any given LED will vary. Output plots and nominal wavelength specs are only intended to be used as a guideline.
- Click for LED Product Photo
- When Driven at the Max Current
- Irradiance is measured at a distance of 200 mm from the LED. Typical value unless otherwise noted
- Measured at 25 °C.
- When Driven at a Current of 350 mA
- This is a four-channel driver and requires the DC4100-HUB connector hub to drive mounted LEDs.

Part Number	Description	Price	Availability
M265L5	NEW! 265 nm, 38.4 mW (Min) Mounted LED, 440 mA	\$450.27	Today
M275L4	275 nm, 45 mW (Min) Mounted LED, 700 mA	\$380.60	Today
M280L6	280 nm, 78 mW (Min) Mounted LED, 500 mA	\$403.96	7-10 Days
M300L4	300 nm, 26 mW (Min) Mounted LED, 350 mA	\$510.22	Today
M310L1	308 nm, 38.5 mW (Min), Mounted LED, 600 mA	\$576.15	Today
M325L5	325 nm, 25 mW (Min) Mounted LED, 600 mA	\$666.25	Today
M340L4	340 nm, 53 mW (Min) Mounted LED, 700 mA	\$320.55	Lead Time

UV Mounted LEDs (365 - 405 nm)

Please note that our UV LEDs radiate intense UV light during operation. Precautions must be taken to prevent looking directly at the UV light, and UV light protective glasses must be worn to avoid eye damage. Exposure of the skin and other body parts to the UV light should be avoided.

Item #	Info ^a	Nominal Wavelength ^b	Housing Type ^c	LED Output Power (Min / Typ.) ^{b,d}	Bandwidth (FWHM)	Irradiance (Typ.) ^e	Max Current (CW)	Forward Voltage (Typ.)	Viewing Angle (Full Angle at Half Max)	Recommended Driver
M365L3		365 nm		880 mW / 1290 mW	9 nm	14.4 μW/mm ²	1000 mA	3.85 V	120°	UPLED, DC2200, LEDD1B, DC4100 ^f , or DC4104 ^f
M365LP1		365 nm		1350 mW / 2000 mW	9 nm	21.0 μW/mm ²	1700 mA	4.0 V	120°	DC2200
M375L4		375 nm		1270 mW / 1540 mW	9 nm	19.2 μW/mm ²	1400 mA	3.6 V	130°	
M385L2		385 nm		270 mW / 430 mW	10 nm	11.8 μW/mm ²	700 mA	4.3 V	120°	UPLED, DC2200, LEDD1B, DC4100 ^f , or DC4104 ^f
M385L3		385 nm		1240 mW / 1780 mW	11 nm	19.9 μW/mm ²	1000 mA	3.7 V	120°	
M385LP1		385 nm		1650 mW / 1830 mW	12 nm	23.3 μW/mm ²	1700 mA	3.9 V	120°	

M395L4		395 nm		400 mW / 535 mW	16 nm	6.7 $\mu\text{W}/\text{mm}^2$	500 mA	4.5 V	126°	UPLED, DC2200, LEDD1B, DC4100 ^f , or DC4104 ^f
M395L5		395 nm		1130 mW / 1630 mW	11 nm	16.9 $\mu\text{W}/\text{mm}^2$	1000 mA	3.7 V	120°	
M395LP1		395 nm		1420 mW / 2050 mW	11 nm	22.8 $\mu\text{W}/\text{mm}^2$	1400 mA	4.0 V	120°	DC2200
M405L4		405 nm		1000 mW / 1300 mW	12.5 nm	14.53 $\mu\text{W}/\text{mm}^2$	1000 mA	3.4 V	140°	UPLED, DC2200, LEDD1B, DC4100 ^f , or DC4104 ^f
M405LP1		405 nm		1200 mW / 1700 mW	12 nm	24.6 $\mu\text{W}/\text{mm}^2$	1400 mA	3.45 V	120°	

- Click on the blue info icon for complete specifications and LED spectrum.
- Due to variations in the manufacturing process and operating parameters such as temperature and current, the actual spectral output of any given LED will vary. Output plots and nominal wavelength specs are only intended to be used as a guideline.
- Click for LED Product Photo
- When Driven at the Max Current
- Irradiance is measured at a distance of 200 mm from the LED.
- This is a four-channel driver and requires the DC4100-HUB connector hub to drive mounted LEDs.

Part Number	Description	Price	Availability
M365L3	365 nm, 880 mW (Min) Mounted LED, 1000 mA	\$389.50	Today
M365LP1	365 nm, 1350 mW (Min) Mounted LED, 1700 mA	\$472.51	7-10 Days
M375L4	375 nm, 1270 mW (Min) Mounted LED, 1400 mA	\$184.86	Today
M385L2	385 nm, 270 mW (Min) Mounted LED, 700 mA	\$287.00	Today
M385L3	385 nm, 1240 mW (Min) Mounted LED, 1000 mA	\$389.50	Today
M385LP1	385 nm, 1650 mW (Min) Mounted LED, 1700 mA	\$472.51	Today
M395L4	395 nm, 400 mW (Min) Mounted LED, 500 mA	\$287.00	Today
M395L5	395 nm, 1130 mW (Min) Mounted LED, 1000 mA	\$389.50	Today
M395LP1	395 nm, 1420 mW (Min) Mounted LED, 1400 mA	\$472.51	Today
M405L4	405 nm, 1000 mW (Min) Mounted LED, 1000 mA	\$239.24	Today
M405LP1	405 nm, 1200 mW (Min) Mounted LED, 1400 mA	\$472.51	Today

Single-Color Cold Visible Mounted LEDs (415 - 565 nm)

Please note that the 415 nm (violet), 430 nm (violet), and 450 nm (royal blue) LEDs radiate intense UV light during operation. Precautions must be taken to prevent looking directly at the UV light, and UV light protective glasses must be worn to avoid eye damage. Exposure of the skin and other body parts to the UV light should be avoided.

Item #	Info ^a	Nominal Wavelength ^{b,c}	Housing Type ^d	LED Output Power (Min / Typ.) ^{b,e}	Bandwidth (FWHM)	Irradiance (Typ.) ^f	Max Current (CW)	Forward Voltage ^g	Viewing Angle (Full Angle at Half Max)	Recommended Driver
M415L4 ^h		415 nm (Violet)		1310 mW / 1550 mW	14 nm	15.6 $\mu\text{W}/\text{mm}^2$	1500 mA	3.1 V	138°	DC2200
M415LP1 ^h		415 nm (Violet)		1640 mW / 1940 mW	14 nm	19.5 $\mu\text{W}/\text{mm}^2$	2000 mA	3.15 V	138°	
M430L5		430 nm (Violet)		529.2 mW / 757.6 mW	17 nm	25.7 $\mu\text{W}/\text{mm}^2$	500 mA	3.66 V	126°	UPLED, DC2200, LEDD1B, DC4100 ⁱ , or DC4104 ⁱ
M450LP2		450 nm (Royal Blue)		2118.1 mW / 3041.5 mW ^l	18 nm ^j	34.2 $\mu\text{W}/\text{mm}^2$ e,j	2000 mA ^l	3.2 V ^{e,j}	120° ^{j,k}	DC2200
M455L4		455 nm (Royal Blue)		1150 mW / 1445 mW	18 nm	32 $\mu\text{W}/\text{mm}^2$	1000 mA	3.25 V	80°	UPLED, DC2200,
M470L5		470 nm (Blue)		809 mW / 1161.7 mW	28 nm	2	1000 mA	3.8 V	80°	









						21.4 $\mu\text{W}/\text{mm}^2$					LEDD1B, DC4100 ⁱ , or DC4104 ⁱ
M490L4		490 nm (Blue)		205 mW / 240 mW	26 nm	2.5 $\mu\text{W}/\text{mm}^2$	350 mA	3.8 V	128°		
M505L4		505 nm (Cyan)		400 mW / 520 mW	37 nm	5.94 $\mu\text{W}/\text{mm}^2$	1000 mA	3.5 V	130°		
M530L4		530 nm (Green)		370 mW / 480 mW	35 nm	9.46 $\mu\text{W}/\text{mm}^2$	1000 mA	3.6 V	80°		
MINTL5		554 nm (Mint)		650 mW / 815 mW	-	12.4 $\mu\text{W}/\text{mm}^2$	1225 mA	3.5 V	120°		DC2200 or LEDD1B ⁱ
M565L3^m		565 nm (Lime)		880 mW / 979 mW	104 nm	11.7 $\mu\text{W}/\text{mm}^2$	1000 mA	3.1 V (Max)	125°		UPLED, DC2200, LEDD1B, DC4100 ⁱ , or DC4104 ⁱ

- Click on the blue info icon for complete specifications and LED spectrum.
- Due to variations in the manufacturing process and operating parameters such as temperature and current, the actual spectral output of any given LED will vary. Output plots and nominal wavelength specs are only intended to be used as a guideline.
- The nominal wavelength indicates the wavelength at which the LED appears brightest to the human eye. The nominal wavelength for visible LEDs may not correspond to the peak wavelength as measured by a spectrometer.
- Click for LED Product Photo
- When Driven at the Max Current
- Irradiance is measured at a distance of 200 mm from the LED.
- Values are typical unless otherwise stated.
- This LED radiates intense UV light during operation. Precautions must be taken to prevent looking directly at the UV light and UV light protective glasses must be worn to avoid eye damage. Exposure of the skin and other body parts to the UV light should be avoided.
- This is a four-channel driver and requires the DC4100-HUB connector hub to drive mounted LEDs.
- Measured at 25 °C
- When Driven at 700 mA Current
- Due to the maximum current that can be provided by this driver, while this mounted LED can be driven, it will not reach full power.
- This LED is phosphor-converted and may not turn off completely when modulated above 10 kHz at duty cycles below 50%.

Part Number	Description	Price	Availability
M415L4	415 nm, 1310 mW (Min) Mounted LED, 1500 mA	\$217.48	Today
M415LP1	415 nm, 1640 mW (Min) Mounted LED, 2000 mA	\$326.23	Today
M430L5	430 nm, 529.2 mW (Min) Mounted LED, 500 mA	\$201.98	7-10 Days
M450LP2	NEW! 450 nm, 2118.1 mW (Min) Mounted LED, 2000 mA	\$248.46	7-10 Days
M455L4	455 nm, 1150 mW (Min) Mounted LED, 1000 mA	\$226.83	Today
M470L5	470 nm, 809 mW (Min) Mounted LED, 1000 mA	\$227.92	Lead Time
M490L4	490 nm, 205 mW (Min) Mounted LED, 350 mA	\$211.85	Today
M505L4	505 nm, 520 mW (Typ.) Mounted LED, 1000 mA	\$303.91	Today
M530L4	530 nm, 370 mW (Min) Mounted LED, 1000 mA	\$303.91	Today
MINTL5	554 nm, 650 mW (Min) Mounted LED, 1225 mA	\$290.33	Today
M565L3	565 nm, 880 mW (Min) Mounted LED, 1000 mA	\$239.58	Today

Single-Color Warm Visible Mounted LEDs (590 - 730 nm)















Item #	Info ^a	Nominal Wavelength ^{b,c}	Housing Type ^d	LED Output Power (Min / Typ.) ^{b,e}	Bandwidth (FWHM)	Irradiance (Typ.) ^f	Max Current (CW)	Forward Voltage (Typ.)	Viewing Angle (Full Angle at Half Max)	Recommended Driver
M590L4		590 nm (Amber)		230 mW / 300 mW	15 nm	6.0 $\mu\text{W}/\text{mm}^2$	1000 mA	2.5 V	80°	UPLED, DC2200, LEDD1B, DC4100 ^h , or DC4104 ^h
M595L4^g		595 nm (Amber)		820 mW / 1217 mW	64 nm	13.5 $\mu\text{W}/\text{mm}^2$	1500 mA	3.0 V	120°	DC2200
M617L3		617 nm (Orange)		600 mW / 650 mW	18 nm	15.7 $\mu\text{W}/\text{mm}^2$	1000 mA	2.2 V	80°	UPLED, DC2200,

M625L4		625 nm (Red)		700 mW / 920 mW	17 nm	21.9 $\mu\text{W}/\text{mm}^2$	1000 mA	2.5 V	80°	LEDD1B, DC4100 ^h , or DC4104 ^h
M660L4		660 nm (Deep Red)		940 mW / 1050 mW	20 nm	20.88 $\mu\text{W}/\text{mm}^2$	1200 mA	2.6 V	120°	UPLD, DC2200 or LEDD1B
M680L4		680 nm (Deep Red)		180 mW / 210 mW	22 nm	14.5 $\mu\text{W}/\text{mm}^2$	600 mA	2.5 V	18°	UPLD, DC2200, LEDD1B, DC4100 ^h , or DC4104 ^h
M700L4		700 nm (Deep Red)		80 mW / 125 mW	20 nm	1.0 $\mu\text{W}/\text{mm}^2$	500 mA	2.7 V	128°	
M730L5		730 nm (Far Red)		540 mW / 680 mW	40 nm	13.1 $\mu\text{W}/\text{mm}^2$	1000 mA	2.25 V	80°	

- Click on the blue info icon for complete specifications and LED spectrum.
- Due to variations in the manufacturing process and operating parameters such as temperature and current, the actual spectral output of any given LED will vary. Output plots and nominal wavelength specs are only intended to be used as a guideline.
- The nominal wavelength indicates the wavelength at which the LED appears brightest to the human eye. The nominal wavelength for visible LEDs may not correspond to the peak wavelength as measured by a spectrometer.
- Click for LED Product Photo
- When Driven at the Max Current
- Irradiance is measured at a distance of 200 mm from the LED.
- This LED is phosphor-converted and may not turn off completely when modulated above 10 kHz at duty cycles below 50%.
- This is a four-channel driver and requires the DC4100-HUB connector hub to drive mounted LEDs.

Part Number	Description	Price	Availability
M590L4	590 nm, 230 mW (Min) Mounted LED, 1000 mA	\$221.71	Today
M595L4	595 nm, 820 mW (Min) Mounted LED, 1500 mA	\$256.25	Today
M617L3	617 nm, 600 mW (Min) Mounted LED, 1000 mA	\$168.92	Today
M625L4	625 nm, 700 mW (Min) Mounted LED, 1000 mA	\$221.71	7-10 Days
M660L4	660 nm, 940 mW (Min) Mounted LED, 1200 mA	\$239.58	Today
M680L4	Customer Inspired! 680 nm, 180 mW (Min) Mounted LED, 600 mA	\$215.18	Today
M700L4	700 nm, 80 mW (Min) Mounted LED, 500 mA	\$215.18	Today
M730L5	730 nm, 540 mW (Min) Mounted LED, 1000 mA	\$226.99	Today

IR Mounted LEDs (780 - 1650 nm)

Item #	Info ^a	Nominal Wavelength ^b	Housing Type ^c	LED Output Power (Min / Typ.) ^{b,d}	Bandwidth (FWHM)	Irradiance (Typ.) ^e	Max Current (CW)	Forward Voltage (Typ.)	Viewing Angle (Full Angle at Half Max)	Recommended Driver
M780L3		780 nm		200 mW / 300 mW	28 nm	47.3 $\mu\text{W}/\text{mm}^2$	800 mA	2.0 V	20°	UPLD, DC2200, LEDD1B, DC4100 ^f , or DC4104 ^f
M780LP1		780 nm		800 mW / 950 mW	30 nm	13.3 $\mu\text{W}/\text{mm}^2$	800 mA	6.6 V	120°	UPLD, DC2200 or LEDD1B
M810L3		810 nm		325 mW / 375 mW	25 nm	61.8 $\mu\text{W}/\text{mm}^2$	500 mA	3.6 V	20°	UPLD, DC2200, LEDD1B, DC4100 ^f , or DC4104 ^f
M810L4		810 nm		363 mW / 542 mW	32 nm	23.7 $\mu\text{W}/\text{mm}^2$	1000 mA	3.55 V	80°	
M850L3		850 nm		900 mW / 1100 mW	30 nm	22.9 $\mu\text{W}/\text{mm}^2$	1200 mA	2.95 V	90°	UPLD, DC2200, or LEDD1B
M850LP1		850 nm		1400 mW / 1600 mW	30 nm	19.4 $\mu\text{W}/\text{mm}^2$	1500 mA	3.85 V	150°	DC2200
M880L3		880 nm		300 mW / 350 mW	50 nm	5.6 $\mu\text{W}/\text{mm}^2$	1000 mA	1.7 V	132°	

M940L3		940 nm		800 mW / 1000 mW	37 nm	19.1 $\mu\text{W}/\text{mm}^2$	1000 mA	2.75 V	90°	UPLD, DC2200, LEDD1B, DC4100 ^f , or DC4104 ^f
M970L4		970 nm		600 mW / 720 mW	60 nm	7.4 $\mu\text{W}/\text{mm}^2$	1000 mA	1.9 V	130°	
M1050L2		1050 nm		50 mW / 70 mW	60 nm	1.9 $\mu\text{W}/\text{mm}^2$	700 mA	1.5 V	120°	
M1050L4		1050 nm		160 mW / 210 mW	37 nm	3.7 $\mu\text{W}/\text{mm}^2$	600 mA	1.4 V	128°	
M1100L1		1100 nm		168 mW / 252 mW ^g	50 nm ^g	18.1 $\mu\text{W}/\text{mm}^2$ ^{d,g}	1000 mA ^g	1.4 V ^{d,g}	18° ^{g,h}	
M1200L3		1200 nm		30 mW / 35 mW	80 nm	0.7 $\mu\text{W}/\text{mm}^2$	700 mA	1.4 V	134°	
M1300L3		1300 nm		25 mW / 30 mW	80 nm	0.6 $\mu\text{W}/\text{mm}^2$	500 mA	1.4 V	134°	
M1450L4		1450 nm		81.8 mW / 120.7 mW	95 nm	1.5 $\mu\text{W}/\text{mm}^2$	1000 mA	1.88 V	130°	
M1550L3		1550 nm		31 mW / 36 mW	102 nm	0.5 $\mu\text{W}/\text{mm}^2$	1000 mA	1.35 V	136°	
M1650L4		1650 nm		13 mW / 16 mW	120 nm	1.2 $\mu\text{W}/\text{mm}^2$	600 mA	1.1 V	20°	

- Click on the blue info icon for complete specifications and LED spectrum.
- Due to variations in the manufacturing process and operating parameters such as temperature and current, the actual spectral output of any given LED will vary. Output plots and nominal wavelength specs are only intended to be used as a guideline.
- Click for LED Product Photo
- When Driven at the Max Current
- Irradiance is measured at a distance of 200 mm from the LED.
- This is a four-channel driver and requires the DC4100-HUB connector hub to drive mounted LEDs.
- Measured at 25 °C
- When Driven at a Current of 100 mA

Part Number	Description	Price	Availability
M780L3	780 nm, 200 mW (Min) Mounted LED, 800 mA	\$239.58	Today
M780LP1	780 nm, 800 mW (Min) Mounted LED, 800 mA	\$362.71	7-10 Days
M810L3	810 nm, 325 mW (Min) Mounted LED, 500 mA	\$222.95	Lead Time
M810L4	810 nm, 363 mW (Min) Mounted LED, 1000 mA	\$261.38	7-10 Days
M850L3	850 nm, 900 mW (Min) Mounted LED, 1200 mA	\$239.58	Today
M850LP1	850 nm, 1400 mW (Min) Mounted LED, 1500 mA	\$379.34	Today
M880L3	880 nm, 300 mW (Min) Mounted LED, 1000 mA	\$239.58	7-10 Days
M940L3	940 nm, 800 mW (Min) Mounted LED, 1000 mA	\$239.58	Today
M970L4	970 nm, 600 mW (Min) Mounted LED, 1000 mA	\$184.86	Lead Time
M1050L2	Customer Inspired! 1050 nm, 50 mW (Min) Mounted LED, 700 mA	\$257.33	Today
M1050L4	1050 nm, 160 mW (Min) Mounted LED, 600 mA	\$313.18	Today
M1100L1	1100 nm, 168 mW (Min) Mounted LED, 1000 mA	\$330.51	Today
M1200L3	Customer Inspired! 1200 nm, 30 mW (Min) Mounted LED, 700 mA	\$239.10	Today
M1300L3	Customer Inspired! 1300 nm, 25 mW (Min) Mounted LED, 500 mA	\$239.10	Today
M1450L4	1450 nm, 81.8 mW (Min) Mounted LED, 1000 mA	\$314.29	Today
M1550L3	Customer Inspired! 1550 nm, 31 mW (Min) Mounted LED, 1000 mA	\$319.44	Today
M1650L4	1650 nm, 13 mW (Min) Mounted LED, 600 mA	\$318.61	Today

Mid-IR Mounted LEDs (3400 - 4300 nm)



Item #	Info ^a	Nominal Wavelength ^b	Housing Type ^c	LED Output Power (Min / Typ.) ^{b,d,e}	Bandwidth (FWHM) ^d	Max Current (CW) ^d	Forward Voltage (Typ.) ^{d,e}	Viewing Angle (Full Angle at Half Max)	Recommended Driver
M3400L1		3400 nm		2.2 mW / 3.3 mW	800 nm	200 mA	4.1 V	130°	UPLD, DC2200, LEDD1B, DC4100 ^f , or DC4104 ^f
M4300L1		4300 nm		1.1 mW / 1.67 mW	800 nm	200 mA	3.9 V	130°	

- a. Click on the blue info icon for complete specifications and LED spectrum.
- b. Due to variations in the manufacturing process and operating parameters such as temperature and current, the actual spectral output of any given LED will vary. Output plots and nominal wavelength specs are only intended to be used as a guideline.
- c. Click for LED Product Photo
- d. Measured at 25 °C
- e. When Driven at the Maximum Current
- f. This is a four-channel driver and requires the DC4100-HUB connector hub to drive mounted LEDs.

Part Number	Description	Price	Availability
M3400L1	NEW! 3400 nm, 2.2 mW (Min) Mounted LED, 200 mA	\$1,216.28	Today
M4300L1	NEW! 4300 nm, 1.1 mW (Min) Mounted LED, 200 mA	\$1,216.28	Today

Purple Mounted LED (455 nm / 640 nm)

Our dual-peak LED was designed for applications requiring illumination in both red and blue portions of the spectrum, such as horticulture. This purple LED features dual peaks at 455 nm and 640 nm, respectively, to stimulate photosynthesis (see graph to compare the absorption peaks of photosynthesis pigments with the LED spectrum). The LED was designed to maintain the red/blue ratio of the emission spectrum over its lifetime to provide high uniformity of plant growth.

Item #	Info ^a	Nominal Wavelength ^b	Housing Type ^c	LED Output Power (Min / Typ.) ^{b,d}	Bandwidth (FWHM)	Irradiance (Typ.) ^e	Max Current (CW)	Forward Voltage (Typ.)	Viewing Angle (Full Angle at Half Max)	Recommended Driver
MPPR1L4 ^f		455 nm (12.5% ^g) / 640 nm		275 mW / 325 mW	N/A	3.7 $\mu\text{W}/\text{mm}^2$	300 mA	3.1 V	115°	UPLED, DC2200, LEDD1B, DC4100 ^h , or DC4104 ^h

- a. Click on the blue info icon for complete specifications and LED spectrum.
- b. Due to variations in the manufacturing process and operating parameters such as temperature and current, the actual spectral output of any given LED will vary. Output plots and nominal wavelength specs are only intended to be used as a guideline.
- c. Click for LED Product Photo
- d. When Driven at the Max Current
- e. Irradiance is measured at a distance of 200 mm from the LED.
- f. This LED is phosphor-converted and may not turn off completely when modulated above 10 kHz at duty cycles below 50%.
- g. Percentage of LED intensity that emits in the blue portion of the spectrum, from 400 nm to 525 nm. Click on the info icon for details.
- h. This is a four-channel driver and requires the DC4100-HUB connector hub to drive mounted LEDs.

Part Number	Description	Price	Availability
MPPR1L4	455 nm (12.5%) / 640 nm, 275 mW (Min) Mounted LED, 300 mA	\$163.12	7-10 Days

White Mounted LEDs (400 - 700 nm Wavelength Range)

Our warm, neutral, and cold white LEDs feature broad spectra that span several hundred nanometers. The difference in appearance among these LEDs can be described using the correlated color temperature, which indicates that the LEDs color appearance is similar to a black body radiator at that temperature. In general, warm white LEDs offer a spectrum similar to a tungsten source, while cold white LEDs have a stronger blue component to the spectrum; neutral white LEDs provide a more even illumination spectrum over the visible range than warm white or cold white LEDs. Cold white LEDs are more suited for fluorescence microscopy applications or cameras with white balancing, because of a higher intensity at most wavelengths compared to warm white LEDs. Neutral white LEDs are ideal for horticultural applications.

Item #	Info ^a	Correlated Color Temperature ^b	Housing Type ^c	LED Output Power (Min / Typ.) ^{b,d}	Bandwidth (FWHM)	Irradiance (Typ.) ^e	Max Current (CW)	Forward Voltage (Typ.)	Viewing Angle (Full Angle at Half Max)	Recommended Driver
MWWHL4 ^f		3000 K (Warm White)		570 mW / 640 mW	N/A	9.4 $\mu\text{W}/\text{mm}^2$	1000 mA	3.0 V	120°	UPLED, DC2200, LEDD1B, DC4100 ^g , or DC4104 ^g
MWWHLP2 ^f		3000 K (Warm White)		1713 mW / 2499 mW ^h	N/A	27.2 $\mu\text{W}/\text{mm}^2$ ^{d,h}	700 mA ^h	12.1 V ^{d,h}	135° ^h	DC2200



MWUVL1^f		4000 K ⁱ (Neutral White)		235 mW / 338 mW	N/A	4.0 $\mu\text{W}/\text{mm}^2$ ^{d,h}	125 mA	6.3 V	120° ⁱ	UPLED, DC2200, or LEDD1B
MNWHL4^f		4900 K (Neutral White)		740 mW / 880 mW	N/A	7.7 $\mu\text{W}/\text{mm}^2$	1225 mA	2.9 V	150°	DC2200, LEDD1B ^k , DC4100 ^{g,k} , or DC4104 ^{g,k}
MCWHL7^f		6500 K (Cold White)		930 mW / 1370 mW	N/A	25.9 $\mu\text{W}/\text{mm}^2$ ^d	1300 mA	3.3 V	80°	
MCWHLP2^f		6500 K (Cold White)		942 mW / 1353 mW	N/A	11.8 $\mu\text{W}/\text{mm}^2$ ^{d,h}	1300 mA	4.51 V	150°	DC2200
MCWHLP3^f		6500 K (Cold White)		2064.8 mW / 2998.0 mW ^h	N/A	33.3 $\mu\text{W}/\text{mm}^2$ ^{d,h}	700 mA ^h	12.9 V ^{d,h}	135° ^h	DC2200

- Click on the blue info icon for complete specifications and LED spectrum.
- Due to variations in the manufacturing process and operating parameters such as temperature and current, the actual spectral output of any given LED will vary. Output plots and correlated color temperature specs are only intended to be used as a guideline.
- Click for LED Product Photo
- When Driven at the Max Current
- Irradiance is measured at a distance of 200 mm from the LED.
- These LEDs are phosphor-converted and may not turn off completely when modulated above 10 kHz at duty cycles below 50%.
- This is a four-channel driver and requires the DC4100-HUB connector hub to drive mounted LEDs.
- Measured at 25 °C
- Neutral White LED Spectrum with a Peak at 406 nm
- When Driven with a Pulsed Forward Current of 75 mA
- Due to the maximum current that can be provided by this driver, while this mounted LED can be driven, it will not reach full power.

Part Number	Description	Price	Availability
MWWHL4	3000 K, 570 mW (Min) Mounted LED, 1000 mA	\$187.45	Today
MWWHLP2	NEW! 3000 K, 1713 mW (Min) Mounted LED, 700 mA	\$267.61	Today
MWUVL1	4000 K, 235 mW (Min) Mounted LED, 125 mA	\$166.76	Today
MNWHL4	4900 K, 740 mW (Min) Mounted LED, 1225 mA	\$163.12	Today
MCWHL7	6500 K, 930 mW (Min) Mounted LED, 1300 mA	\$220.45	7-10 Days
MCWHLP2	6500 K, 942 mW (Min), Mounted LED, 1300 mA	\$292.58	Today
MCWHLP3	NEW! 6500 K, 2064.8 mW (Min), Mounted LED, 700 mA	\$346.54	Lead Time

Broadband Mounted LEDs

The MBB1L3 broadband LED has a relatively flat spectral emission over a wide wavelength range. Its 10 dB bandwidth ranges between 470 nm and 850 nm. The MBB2L1 and MBB2LP1 broadband LEDs feature a spectrum with peaks at approximately 770 nm, 860 nm, and 940 nm.

Item #	Info ^a	Wavelength ^b	Housing Type ^c	LED Output Power (Min / Typ.) ^{b,d}	Bandwidth (FWHM)	Irradiance (Typ.) ^e	Max Current (CW)	Forward Voltage (Typ.)	Viewing Angle (Full Angle at Half Max)	Recommended Driver
MBB1L3^f		470 - 850 nm (10 dB Bandwidth)		70 mW	280 nm	0.9 $\mu\text{W}/\text{mm}^2$	500 mA	3.6 V	120°	UPLED, DC2200, LEDD1B, DC4100 ^g , or DC4104 ^g
MBB2L1		770 nm, 860 nm, & 940 nm (Peak Wavelengths)		650 mW / 970 mW ^h	N/A	11.9 $\mu\text{W}/\text{mm}^2$ ^{d,h}	800 mA ^h	4.8 V ^h	120° ^h	
MBB2LP1		770 nm, 860 nm, & 940 nm (Peak Wavelengths)		740 mW / 1090 mW ^h	N/A	13.5 $\mu\text{W}/\text{mm}^2$ ^{d,h}	1000 mA ^h	4.8 V ^h	120° ^h	

- Click on the blue info icon for complete specifications and LED spectrum.
- Due to variations in the manufacturing process and operating parameters such as temperature and current, the actual spectral output of any given LED will vary. Output plots and nominal wavelength specs are only intended to be used as a guideline.
- Click for LED Product Photo
- When Driven at the Max Current
- Irradiance is measured at a distance of 200 mm from the LED.
- The LED may not turn off completely when modulated at frequencies above 1 kHz with a duty cycle of 50%, as the broadband emission is produced by optically stimulating emission from phosphor. For modulation at frequencies above 1 kHz, the duty cycle may be reduced. For example, 10 kHz modulation is attainable with a duty cycle of 5%.

- g. This is a four-channel driver and requires the DC4100-HUB connector hub to drive mounted LEDs.
- h. Measured at 25 °C

Part Number	Description	Price	Availability
MBB1L3	470 - 850 nm Mounted Broadband LED, 70 mW (Min), 500 mA	\$559.02	7-10 Days
MBB2L1	IR Mounted Broadband LED (770 nm, 860 nm & 940 nm), 650 mW (Min), 800 mA	\$585.51	7-10 Days
MBB2LP1	IR Mounted Broadband LED (770 nm, 860 nm & 940 nm), 740 mW (Min), 1000 mA	\$684.48	Today

Adjustable Collimation Adapters for Ø1" (Ø25 mm) or Ø2" (Ø50 mm) Optics

- ▶ Integrate a Ø1" (Ø25 mm) or Ø2" (Ø50 mm) Collimation Optic with Thorlabs' Mounted LEDs
- ▶ Adjust and Set Lens Position via Rotating Ring with Locking Setscrew
- ▶ Available with or without AR-Coated Lens (See Table Below for Details)
- ▶ Compatible with Thorlabs' SM2-Threaded Microscope Port Adapters



Click to Enlarge
SM2F Adapter Installed
on a
M365LP1 Mounted LED

These adapters allow Ø1" (Ø25 mm) or Ø2" (Ø50 mm) collimation optics to be integrated with the mounted LEDs sold above. The adapters can translate a Ø1" or Ø2" lens by up to 11 mm or 20 mm, respectively. They are offered in versions without a collimation optic or with a removable AR-coated aspheric condenser lens for 350 - 700 nm or 650 - 1050 nm. All of these adapters attach to the LED housing via external SM1 threads, allowing them to be used with both the Ø30.5 mm and Ø57.0 mm housings.

The collimation lens is mounted in an inner carriage that provides non-telescoping, rotating translation along the Z-axis by turning the knurled adjustment ring (engraved with the item # in the photos to the left) and is locked into position by turning the locking screw on the side of the adjustment ring with a 2 mm (5/64") hex key. Lines, spaced 2 mm apart, are engraved on the housing as a rough guide for how far the carriage has been translated. These collimation adapters use an extra-thick SM1-threaded or SM2-threaded retaining ring designed for holding aspheric condenser lenses. The retaining rings can be tightened or loosened using either an SPW602 (Ø1" versions) or SPW604 (Ø2" versions) spanner wrench.

The threading on the input and output apertures remain fixed during translation, allowing these adapters to be mounted between fixed lens tubes. These apertures are threaded for compatibility with various components; please see the table below for details.

Inserting or Removing Optics

To insert or remove an optic in these collimation adapters, use the adjustment ring to translate the inner carriage to the output end of the housing. Remove the included retaining ring using the spanner wrench. If there is a lens installed already, remove it from the carriage. Insert another Ø1" (Ø25 mm) or Ø2" (Ø50 mm) optic into the carriage, and use the retaining ring to secure it.

Using a lens with a substrate or AR coating that does not transmit the wavelength of your LED is not recommended. Deep UV LEDs (wavelengths ≤ 340 nm) require a lens fabricated from UV Fused Silica, since many standard varieties of glass do not transmit below 350 nm. IR LEDs that emit at wavelengths ≥ 1050 nm can be collimated using an uncoated condenser lens, such as the Ø50 mm ACL50832U which has a wavelength range of 380 - 2100 nm.

LED Quick Links
Mounted LEDs
Deep UV (265 - 340 nm)
UV (365 - 405 nm)
Cold Visible (420 - 565 nm)
Warm Visible (590 - 730 nm)
IR (780 - 1550 nm)
White (400 - 700 nm)
Broadband (470 - 940 nm)
LED Collimation^a
Adjustable Collimation Adapters
Microscope Collimation Adapters
LED Mating Connector
LED Drivers

- We offer suggestions for how to collimate most of our LEDs. Click on the info icons () above for details.

Item #	Compatible Optic	Lens Travel Range	Input Threading	Output Threading	Included Lens	AR Coating Range	Lens Focal Length	Operating Temperature	Diagram
SM1U ^a	Ø1" (Ø25 mm)	11 mm (0.43")	External SM1 (1.035"-40)	Internal SM2 (2.035"-40) ^b	N/A	N/A	N/A	15 - 60 °C (Non-Condensing)	
SM1U25-A					ACL2520U-A	350 - 700 nm	20.1 mm		
SM1U25-B					ACL2520U-B	650 - 1050 nm	20.1 mm		
SM2F ^a	Ø2" (Ø50 mm)	20 mm (0.79")	External SM1 (1.035"-40) ^c	Internal SM2 (2.035"-40) ^d	N/A	N/A	N/A		
SM2F32-A					ACL50832U-A	350 - 700 nm	32.0 mm		
SM2F32-B					ACL50832U-B	650 - 1050 nm	32.0 mm		

- The SM1U and SM2F do not include a collimation optic, allowing user-supplied optics, such as our aspheric condenser lenses, to be integrated with Thorlabs' mounted LEDs.
- This thread is part of a removable adapter; removing the adapter reveals internal M34 x 0.5 threading. The SM1A38 thread adapter can be used in place of this adapter for SM1 compatibility.
- This thread is part of a removable adapter; removing the adapter reveals external SM2 (2.035"-40) threading.
- This thread is part of a removable adapter; removing the adapter reveals internal M62 x 0.75 threading.

Part Number	Description	Price	Availability
SM1U	Adjustable Collimation Adapter for Ø1" or Ø25 mm Optic	\$277.78	Today
SM1U25-A	Adjustable Collimation Adapter with Ø1" Lens, AR Coating: 350 - 700 nm	\$295.20	Today
SM1U25-B	Adjustable Collimation Adapter with Ø1" Lens, AR Coating: 650 - 1050 nm	\$295.20	Today
SM2F	Adjustable Collimation Adapter for Ø2" or Ø50 mm Optic	\$275.08	Today
SM2F32-A	Adjustable Collimation Adapter with Ø2" Lens, AR Coating: 350 - 700 nm	\$292.82	Today
SM2F32-B	Adjustable Collimation Adapter with Ø2" Lens, AR Coating: 650 - 1050 nm	\$292.82	Today

Microscope Collimation Adapters with Ø50 mm Lens

- ▶ AR-Coated Aspheric Lens with Low f/# (Approximately 0.8)
- ▶ Compatible with Select Leica, Nikon, Olympus, or Zeiss Microscopes
- ▶ Easily Adjust Beam Collimation / Focus
- ▶ Requires SM2T2 Coupler and SM1A2 Adapter (Each Sold Separately) when Used with the LEDs Above



Click for Details
 Installation of a collimation adapter to a mounted LED using the SM2T2 and SM1A2 thread adapters. The same setup can be used to attach the collimation adapter to the LEDs above that use a Ø57.0 mm housing.

Thorlabs offers collimation adapters with Ø50 mm AR-coated aspheric condenser lenses (EFL: 40 mm) for collimating the output from the mounted LEDs sold above. Two AR coating ranges (350 - 700 nm and 650 - 1050 nm) and four different collimator housings are available. Each housing is designed with a dovetail or bayonet mount to mate to the illumination port on selected Olympus*, Leica, Nikon, or Zeiss microscopes. Compatible microscopes are listed in the Collimation Adapter Selection Guide table below.

Using an adapter with a substrate or AR coating that does not transmit the wavelength of your LED is not recommended. Deep UV LEDs (M265L3, M280L3, and M340L3) require a lens fabricated from UV Fused Silica, since many standard varieties of glass do not transmit below 350 nm. IR LEDs that emit beyond 1050 nm (M1200L3, M1300L3, and M1550L3) can be collimated using an uncoated condenser lens; the ACL5040U is an uncoated version of the Ø50 mm lenses used in the collimation packages below that has a wavelength range of 380 - 2100 nm. See the *Collimation Adapter* tab in the info icons above for additional collimation options.

The LED sources described above can be fitted to the collimators by using an SM2T2 Coupler and SM1A2 Adapter (not included) as shown in the image at right. This assembly can be easily adapted to different LED sources by unscrewing the LED housing.

*Please note that due to the optical design of the transmitted lamphouse port of the BX and IX microscopes, it may be necessary to purchase a separate adapter, which is available from Olympus.

LED Quick Links
Mounted LEDs
Deep UV (265 - 340 nm)
UV (365 - 405 nm)
Cold Visible (420 - 565 nm)
Warm Visible (590 - 730 nm)
IR (780 - 1550 nm)
White (400 - 700 nm)
Broadband (470 - 850 nm)
LED Collimation^a
Adjustable Collimation Adapters
Microscope Collimation Adapters
LED Mating Connector
LED Drivers

- We offer suggestions for how to collimate most of our LEDs. Click on the info icons () above for details.

Collimation Adapter Selection Guide						
Compatible Microscopes			Olympus BX & IX ^a	Leica DMI	Zeiss Axioskop & Examiner ^b	Nikon Eclipse Ti
AR Coating Range of Condenser Lens	Lens Focal Length	Lens Item #	 Click to Enlarge	 Click to Enlarge	 Click to Enlarge	 Click to Enlarge
350 - 700 nm	40.0 mm	ACL5040U-A	COP1-A	COP2-A	COP4-A	COP5-A
650 - 1050 nm	40.0 mm	ACL5040U-B	COP1-B	COP2-B	COP4-B	COP5-B

- Please note that due to the optical design of the transmitted lamphouse port of the BX and IX microscopes it may be necessary to purchase a separate adapter which is available from Olympus.
- These adapters are compatible with any Zeiss microscopes that use the same dovetail as the Zeiss Axioskop or Examiner microscopes.

Part Number	Description	Price	Availability
COP1-A	Collimation Adapter for Olympus BX & IX, AR Coating: 350 - 700 nm	\$205.19	Today
COP1-B	Collimation Adapter for Olympus BX & IX, AR Coating: 650 - 1050 nm	\$239.58	Today
COP2-A	Collimation Adapter for Leica DMI, AR Coating: 350 - 700 nm	\$205.19	Today
COP2-B	Collimation Adapter for Leica DMI, AR Coating: 650 - 1050 nm	\$239.58	7-10 Days
COP4-A	Collimation Adapter for Zeiss Axioskop & Examiner, AR Coating: 350 - 700 nm	\$205.19	7-10 Days
COP4-B	Collimation Adapter for Zeiss Axioskop & Examiner, AR Coating: 650 - 1050 nm	\$239.58	Today
COP5-A	Collimation Adapter for Nikon Eclipse Ti, AR Coating: 350 - 700 nm	\$242.90	Today
COP5-B	Collimation Adapter for Nikon Eclipse Ti, AR Coating: 650 - 1050 nm	\$281.73	Today
SM1A2	Adapter with External SM1 Threads and Internal SM2 Threads	\$26.51	Today
SM2T2	SM2 (2.035"-40) Coupler, External Threads, 1/2" Long	\$38.55	Today

Mounted LED Mating Connector

- ▶ Female 4-Pin Pico (M8) Receptacle
- ▶ M8 x 1 Thread for Connection to Mounted LED Power Cable
- ▶ M8 x 0.5 Panel-Mount Thread for Custom Housings
- ▶ 0.5 m Long, 24 AWG Wires
- ▶ IP 67 and NEMA 6P Rated

The CON8ML-4 connector can be used to mate mounted LEDs featured on this page to user-supplied power supplies. We also offer a male 4-Pin M8 connector cable (item # CAB-LEDD1).

Pin	Color	Specification
1	Brown	LED Anode
2	White	LED Cathode
3	Black	EEPROM GND
4	Blue	EEPROM IO

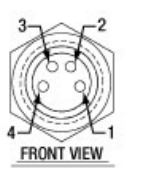

CON8ML-4 Shown Connected to the 4-Pin M8 Plug of Mounted LED

Part Number	Description	Price	Availability
CON8ML-4	4-Pin Female Mating Connector for Mounted LEDs	\$34.11	Today

M340L4 Spectrum

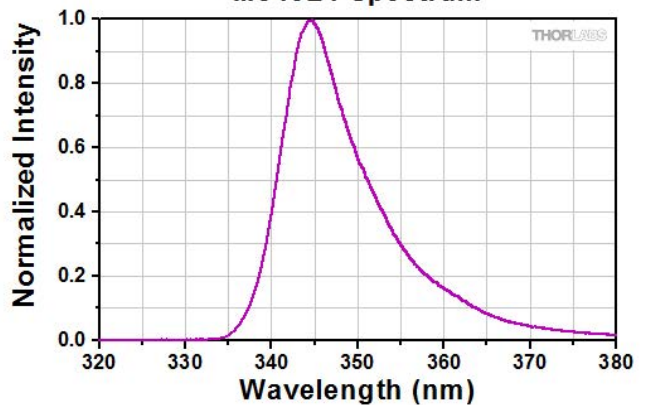

Click [here](#) to download an Excel file containing the spectral data for a larger wavelength range than shown in the graph above.

Due to variations in the manufacturing process and operating parameters such as temperature and current, the actual spectral output of any given LED will vary. This plot is only intended to be used as a guideline.



M340L4 Characteristics ^a				
Optical Specifications	MIN	TYP	MAX	UNIT
Nominal Wavelength ^b	-	340	-	nm
Peak Wavelength	-	338	-	nm
Bandwidth (FWHM)	-	11	-	nm
LED Output Power ^c	53	60	-	mW
Viewing Angle (Full Angle at Half Max)	-	110	-	deg.
Irradiance ^d	-	-	2.22	$\mu\text{W}/\text{mm}^2$
Electrical Specifications				
Current (CW)	-	-	700	mA
Forward Voltage	-	4.6	-	V
Electrical Power	-	3220	-	mW

General Specifications	
Characteristic	Value
Emitter Size	1 mm x 1 mm
Lifetime ^e	>3000 h
Operating Temperature (Non-Condensing)	0 to 40 °C
Storage Temperature	-40 to 70 °C
Risk Group ^f	RG0 - Exempt Group
Housing Diameter	Ø30.5 mm
Mechanical Compatibility	SM1 (1.035"-40) Internal Threads
Cable Length	2 m

- a. This LED radiates intense UV light during operation. Precautions must be taken to prevent looking directly at the UV light and UV light protective glasses must be worn to avoid eye damage. Exposure of the skin and other body parts to the UV light should be avoided.
- b. Due to variations in the manufacturing process and operating parameters such as temperature and current, the actual spectral output of any given LED will vary. The nominal wavelength is only intended to be used as a guideline.
- c. When Driven with the Test Current
- d. Measured at a Distance of 200 mm
- e. Thorlabs defines the lifetime of our LEDs as B_{50}/L_{50} , meaning that 50% of the LEDs with a given item # will fall below 50% of the initial optical power at the end of the specified lifetime. Please see the *Stability* tab for more details.
- f. According to the standard IEC 62471:2006, Photobiological Safety of Lamps and Lamp Systems

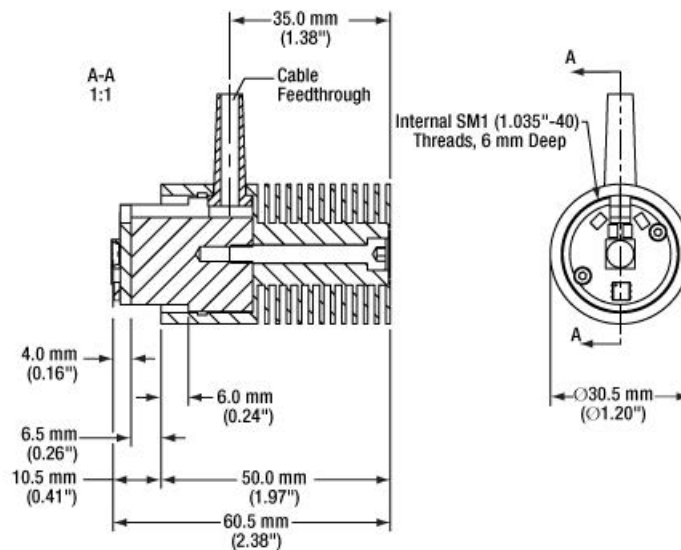

This LED features a Ø30.5 mm heat sink.